



Tunisian Republic
Ministry of Higher Education and Scientific Research
Virtual University Of Tunis

Master's Thesis

In order to graduate the Master Degree in
New Telecommunication Technologies and Networks

Topic:

DESIGN, MODELLING AND IMPLEMENTATION OF A
GEO-ANTITHEFT PROTOTYPE FOR MUSEUM'S
MASTERPIECES

Innovated and realised by:

Faten RIDENE RAISSI

Supervised by:

Pr. Ridha BOUALLEGUE

Mr. Rafik ZAYENI

Supported on: At: UVT

In front of the Jury, composed by:

Xx: President

YY:Rapporteur

Academic Year:

2012-2013

Dedication

For all those who have made me a know-how fan!

For those who have converted, what I saw in dark, as clear as the sun!

For those who can easily distinguish, when I just like from when I have fun!

For a person, too tender, I dreamed of whom, to see me win!

May Allah bless his soul, who was in all this universe's fathers, the best one!



Acknowledgements

We strongly wish to thank all those who helped us from near or far, to get this honourable opportunity to deepen our knowledge level about the smart geo-antitheft security

We thank all those who helped us, in particular:

*Virtual University of Tunisia for having awarded us this honourable opportunity

*Innov'Com for having provided us with the necessary workplace and the equipment we need, for a successful implementation of our End of Studies Project in the most comfortable conditions.

* Our Supervisors: Pr. Ridha BOUALLEGUE and Mr. Rafik ZAYENI whose comments and instructions were for us a great contribution.

*My sweet mother who deeply helped me during all my life to reach this academic level

* My Husband and binomial in studies, who has spared no effort to help me

* Molotov, Brupala, Souma, Mark H-S's group (English and ITC forum usernames) for their interesting indications.

* And finally our best and sincere thanks go to the jury for accepting to evaluate this project.

Abstract

Day after day, the theft protection field is becoming more and more fundamental. That is why we can obviously observe the progress of the automatic identification purposes and the stolen articles tracking. The field of the geoprocessing applications is gaining more importance and the number of software-tools specialized in the handling of the space-time data witnessed a considerable growth during the last decade. Several methods dedicated to the design of geoprocessing tools have been proposed.

Nevertheless, the theft protection field was studied just for the itinerant stolen articles. The different formalisms that exist in the literature such as tablet computers, smart phones and cars, can lead us to clearly deduce that the immobile articles case has never been treated before.

Thus, taking the museum's masterpieces as a primary target, we propose a solution that addresses real time detection constraints in the field of real time geoprocessing applications.

This work has led to a prototype with a CASE (Computer Aided Software Engineering) tool supporting the proposed formalism. A validation through a concrete example enabled us to enrich and improve this prototype.

Key words:

GPS, GPRS, Spatial/Temporal database, GM862, EVK2, VB.net Application

Résumé

Jour après jour, le domaine de protection antivol est de plus en plus fondamental. Par conséquent, on peut évidemment observer les progrès des fins d'identification automatique et de suivi des articles volés. Le champ des applications de géo traitement est de plus en plus fatal et le nombre de logiciels-outils spécialisés dans le traitement des données spatio-temporelles a connu une croissance considérable au cours de cette dernière décennie. Plusieurs méthodes dédiées à la conception d'applications de Géolocalisation ont été proposées.

Néanmoins, le domaine de protection contre le vol a été dédié seulement pour les articles mobiles. Les différents moyens inventés, qui existent dans la littérature comme les ordinateurs tablettes, les téléphones intelligents et les voitures, nous permettent de déduire clairement que le cas des articles immobiles n'a jamais été traité auparavant.

Ainsi, en prenant les chefs-d'œuvre exposés dans les musées en tant que première cible, nous proposons une solution qui répond à de réelles contraintes de temps de détection dans le domaine des applications réelles de traitement géotemporeire.

Ce travail a conduit à un prototype supportant le formalisme proposé. Une validation par un exemple concret nous a permis d'enrichir notre étude.

Mots-clés:

GPS, GPRS, Bases de données spatio-temporelles, GM862-GPS...

تلخيص

يوماً بعد يوم، نجد أنّ مجال الحماية ضدّ السرقة صار ذا أهمية أساسية في طور الصعود. لهذا السبب يمكننا أن نلاحظ بوضوح التقدم المحرز في وسائل التعرف الآلي وتتبع المواد المسروقة. إنّ أهمية مجال تطبيقات تحديد المواقع الجغرافية لا تنفكّ تزداد. وقد وُجِدَتْ عديد من البرمجيات المتخصصة في التعامل مع البيانات الفضائية، وهو ما شهد نمواً كبيراً خلال العقد الأخير من الزمن.

وقد اقترحت عدة طرق مخصصة لتصميم تطبيقات لتحديد الموقع الجغرافي. ومع ذلك فإن مجال الحماية شمل فقط المواد المسروقة المتحركة. ويمكن للشكليات المختلفة التي توجد في الأدبيات مثل أجهزة الكمبيوتر اللوحي والهواتف الذكية والسيارات، أن تجعلنا نستنتج بوضوح أن القضية لم تتم معالجتها من زاوية المواد الثابتة غير المتحركة.

وبالتالي، فإننا نقترح إيجاد حل يلبى حاجة الحماية، متكئين على التحف و اللوحات الزيتية و القطع الأثرية المعروضة في المتاحف كهدف أولي لتجربة الحماية ضدّ السرقة، و ذلك بتجاوز الحماية داخل دور العرض عبر إضافة نمذجة مفاهيمية لتحديد الموقع الجغرافي للقطعة المسروقة لتسهيل استعادتها.

وقد أدى هذا العمل إلى نموذج أولي، و ذلك باستعمال وسيلة هندسة البرمجيات بمساعدة الكمبيوتر (أداة دعم الشكلية المقترحة). و قد تمكنا في نهاية مشروع ختم دراستنا، من الوصول إلى مرحلة اثبات الفكرة من خلال صنع مثال ملموس نثري من خلاله نموذجنا الأولي

الكلمات المفاتيح

نظام تحديد المواقع العالمي (GPS)، خدمة حزمة الراديو العامة (GPRS)، قاعدة البيانات الزمكانية، GM862

Statutory Declaration

1-Declaration:

I declare that this master's thesis is my own work, that it has neither been submitted for any degree in any other university, nor previously published in whole or parts. I also affirm that all the sources I have used or quoted, have been indicated and acknowledged with their absolute references.

2-Intellectual Property:

The opinions expressed in this paper are specific to their author: *Faten RIDENE RAISSI*. The Virtual University of Tunis does neither approve nor disapprove with the views expressed by the author. The policy of the VUT is to vigorously denounce and severely punish any use which is not in accordance with ethics of data or ideas. Any other reproduction that does not meet strictly the law of intellectual property will also be penalised.

Apologies to readers

In many of these thesis' figures, colours have significance. Unfortunately for the reader, it happens that he may have a black and white copy, which makes some of the figures less meaningful. So please accept our apologies.

Glossary

A Alarm, Antenna, artefact, Archaeological, Amphoras,
Amulets

B

C Chip, CMUX, CCTV, Cell-ID,

D Drop down menu, database, detector

E “EVK2: Evaluation kit motherboard”, Excavations

F “Finger print”

G Gantt,GM862,GPS,GPRS

H

I “Infra-red”, ICT, I-articles

JJewels

K Key, “Key card”, “Key code”

L Landmark

M Modem, Mosaics, Masterpiece, Museum, Module,
MySQL,

N Node, NFC

O “Oil Lamps”, OEM: Original Equipment Manufacturer

P Prototype, Python, Painting, Pearl, Portrait, Pottery,
Password, PIM, PID, Pedestal, Polycarbonate

Q

R RFID, Reciever

S Sensor, Subcutaneous, Sim, StarUML, Sculptures

T Token, TTFF, Triangulation

U UMTS

V VB.Net

W WSN, W-CDMA

X

Y

Z

Index

Dedication.....	i
Acknowledgements	ii
Abstract.....	iii
Résumé	iv
تلخيص.....	v
Statutory Declaration	vi
Apologies to readers	vi
Glossary	vii
Index	viii
Figures List.....	xi
Tables List.....	xii
Chapter I:	1
Graduation Project's Framework.....	1
1-Introduction:	2
2-Project's Background:	2
3-Specifications sheet:.....	3
4-Thesis Outline:.....	5
Chapter II:.....	6
State of the Art	6
1-Introduction:	7
2-A comparative study of the already used museums' security systems:	7
3- Benchmarking: Criticism of already existing solutions:	11
4-Smart Geo-Antitheft Solutions are limited to mobile articles:.....	12
5- Innovative solution that meets with our need:	13
6- Anticipated Impact:.....	14
Chapter III:.....	15
Architectural study of the geolocation process.....	15

1. Tracking Technologies:	16
2-Some commercialised tracking technologies examples:	20
Chapter IV.....	22
Our Geo-Antitheft solution for immobile masterpieces	22
1-Introduction:	23
2 -Definition:.....	23
3-Specifications:	24
4-Conclusion:	28
Chapter V:	29
Chosen Tools and Technologies	29
1- Introduction	30
2-Technologies Selection:.....	30
3- Conclusion:	36
Chapter VI:.....	37
Our Geo-Antitheft Application Design.....	37
1- Introduction :.....	38
2-Designing Tool Selection:	38
3-Use-Cases Diagrams:.....	38
4- Activity Diagrams:.....	41
5- Sequence Diagrams:	42
6- Class Diagram:	43
7- Relational model (classes/attributes):.....	45
8-Geo-Antitheft Application Model:	45
9- Graphic Design:	45
10- Conclusion:	46
Chapter VII:.....	47
Development.....	47
1-Work Environment:	48
2- Python Script for GM862-GPS:	50

3-Database creation and connection:	53
4- The tracking windows application on the Museum Local Host:	53
5-Conclusion:	62
Chapter VIII	63
Conclusion and perspectives	63
1-Conclusion:	64
2-Perspectives:	64
3-Recommandations:	64
4-References	65
Appendices.....	66
Appendix I: Presentation of the host institution	67
Appendix II: Museums definition followed by Tunisian Examples	68

Figures List

Fig. I. i Gantt Diagram	3
Fig. I. ii: Prototype	4
Fig. I. iii: General Synoptic	5
Fig. II. i: Museums Physical Security System Overview	8
Fig. II. ii: Pedestals with polycarbonate display cases and locks	9
Fig. II. iii: Passive Infrared Detector	10
Fig. II. iv: The PID's sensing lobe	10
Fig. II. v: CCTV Running	11
Fig. II. vi: Vehicle GPS Tracker	12
Fig. II. vii: Our Prototype's Aim	14
Fig. III. i: Triangulation System	16
Fig. III. ii: NFC application Fields	17
Fig. III. iii: Subcutaneous Micro Chip & RFID Chip	18
Fig. III. iv: GPS Geolocation Principle	19
Fig. III. v: NAO Campus	20
Fig. III. vi: G-Track	21
Fig. IV. i: GM862-GPS Module	23
Fig. IV. ii: GM862-GPS Connectors	24
Fig. IV. iii: GSM and GPS Antennas	25
Fig. IV. iv: The SIM Card holder connection lines	27
Fig. IV. v: Users' Sub-window, used by users	56
Fig. IV. vi: Users' sub-window, used by the administrator	56
Fig. V. i: Python Script Interaction with the GM862-GPS functionalities	31
Fig. V. ii: AN example of the Protocol Stack Involved in the devices	32
Fig. V. iii: Structure of Managing Some I/O pins and GM862-GPS through the AT Command interface	34
Fig. V. iv: Our requirements Schematic Approaches	34
Fig. V. v: Our Project's Architecture-MVC	35
Fig. V. vi: V-Model Life Cycle	36
Fig. VI. i: Geolocation Use-Case	39
Fig. VI. ii: authentication use-case	40
Fig. VI. iii: Administrator use-case	40
Fig. VI. iv: Security agent use-case	41
Fig. VI. v: Checking for Load Activity Diagram	41

Fig. VI. vi: Geo-Antitheft Activity Diagram	42
Fig. VI. vii: Geo-Antitheft Sequence diagram	43
Fig. VI. viii: Class Diagram	44
Fig. VI. ix: Geo-Antitheft Application Model	45
Fig. VII. i: RS232/USB Evaluation Boards - EVK3	48
Fig. VII. ii: RS232 Serial Port connection of EVK	50
Fig. VII. iv: Python Script Importation to the module GM862-GPS	52
Fig. VII. iii: Sim Card connection via AT commands	51
Fig. VII. v: Database Creation on PHP my Admin Tool	53
Fig. VII. vi: Geo-Antitheft Database Connection	53
Fig. VII. vii: Authentication Sub-Window	54
Fig. VII. viii: Error Message	54
Fig. VII. x: Start-up Main Window	55
Fig. VII. ix: Password Recovery	55
Fig. VII. xii: Accounts sub-window	57
Fig. VII. xi: Users' List Sub-Window	57
Fig. VII. xiii: Accounts list sub-window	58
Fig. VII. xiv: Artefacts Managing Sub-Window	58
Fig. VII. xv: Artefacts List Sub-Window	59
Fig. VII. xvi: GM862-GPS Sub-Window	59
Fig. VII. xvii: GM862-GPS List Sub-Window	60
Fig. VII. xviii: Tracking Theft Sub-Window	60
Fig. VII. xix: Tracking History Sub-Window	61
Fig. VII. xx: Help Sub-Window	61
Fig. VII. xxi: The About Sub-Window	62
Appendix 1. 1: The host Institution: Innov'Com	67
Appendix 2. 1: Bardo and Cathage National Museums	68
Appendix 2. 2: Some of Bardo National Museum's Masterpieces	69
Appendix 2. 3: Some of Carthage National Museum's Masterpieces	69

Tables List

Table 1: GSM and GPS Antennas' requirements	25
Table 2: main window design	46
Table 3: Sub Windows Design	46

Chapter I: Graduation Project's Framework

1-Introduction:

During the N2TR's fourth semester, we were asked to perform a graduation project, in order to obtain our Masters Degree Certificate in New Technologies of Telecommunications and Networks. To this end, my innovative idea aims to establish a Smart Geo-Antitheft prototype.

The masterpieces' safety is already staging on the museums, but it is limited to their interior space, and once the stolen article is removed from the museum, we can no longer detect its location.

During the period from February to June, our innovative concept was greeted by an academic institution: Innov'Com, which presentation is added on our first appendix.

2-Project's Background:

From the Stone Age until nowadays, the perfectionist human being's mind has never ceased to improve their daily lives. The transition from mechanical to computing, electronics and automatic fields have revolutionized the people's daily life. New information and communication technologies: ICT, illustrate this phenomenon. Finding that numerous intelligent articles, has become a daily necessity, so that we can substantiate that ICT is no longer optional. That is why we must take care to decrease any risk they are causing.

The rapid progress and the High-Tech evolution, which is growing speedily, lead us to sincerely believe that we must guarantee the best security platforms, through which we can ensure connectivity for I-articles, such as Smart phones, PCs, Macs, iPods or Tablet Computers users, avoiding any risk, as any new practice comes with new threats. We can find a lot of innovated and patented security solutions, but they are only related to I-Articles. These smart goods are so expensive that they deserve caring about their safety, but high value is not only related to the high-tech items; we can find more valuable pearls, which must be more extremely protected.

The term Pearl is not limited just to jewels; Pearl includes some important articles that can be considered as priceless. For example, museums' masterpieces, such as famous paintings, mosaics, sculptures, and many other artefacts' types do really deserve to be protected from theft, as they reflect the countries' glorious history, making it available for public through exhibitions that can be either permanent or temporary. So if we secure them, we will guarantee the country's history for next generations.

Museum's pearls are highly protected on the museums' indoors. When an article is removed from its original place, this can be detected and the artefact can be easily and rapidly returned to its appropriate place. But if one masterpiece is stolen and taken outdoors of the museum, it becomes so hard to find it immediately. Thereby, thieves can find in this short time a gap, to easily take the precious stolen article outside the country's borders, by smuggling during the investigations' period.

In order to avoid this gap, we suggest a little innovation, which boils down on protecting the precious masterpieces against theft, using geolocation as a facility. A model GM862-GPS, for which we present a prototype, would be an appropriate solution which, when added to the artefact, equipped with a nano-sim-card, GPS and GSM antennas, would be able to capture the stolen good's geographical position in real-time, and will

get it back easily and quickly. Once the functionality of the prototype is confirmed, we will use templates kits, which would be more flexible, smaller in size and economic energy consumer standpoint. In this way, we will be able to reduce the contraband risk and protect our precious and priceless history.

3-Specifications sheet:

3.1-Problematic:

All around the world, the museums represent the temple of every country’s cultural heritage; that is why we must implement different security essentials, in order to guaranty the cultural property’s protection.

Nowadays, we can find many security tools used to protect the museums’ masterpieces, but all of them are secured on a very limited geographical area over which we can no more follow them, due to a thieves’ smuggling crafty trick.

3.2- Our project’s Gantt chart:

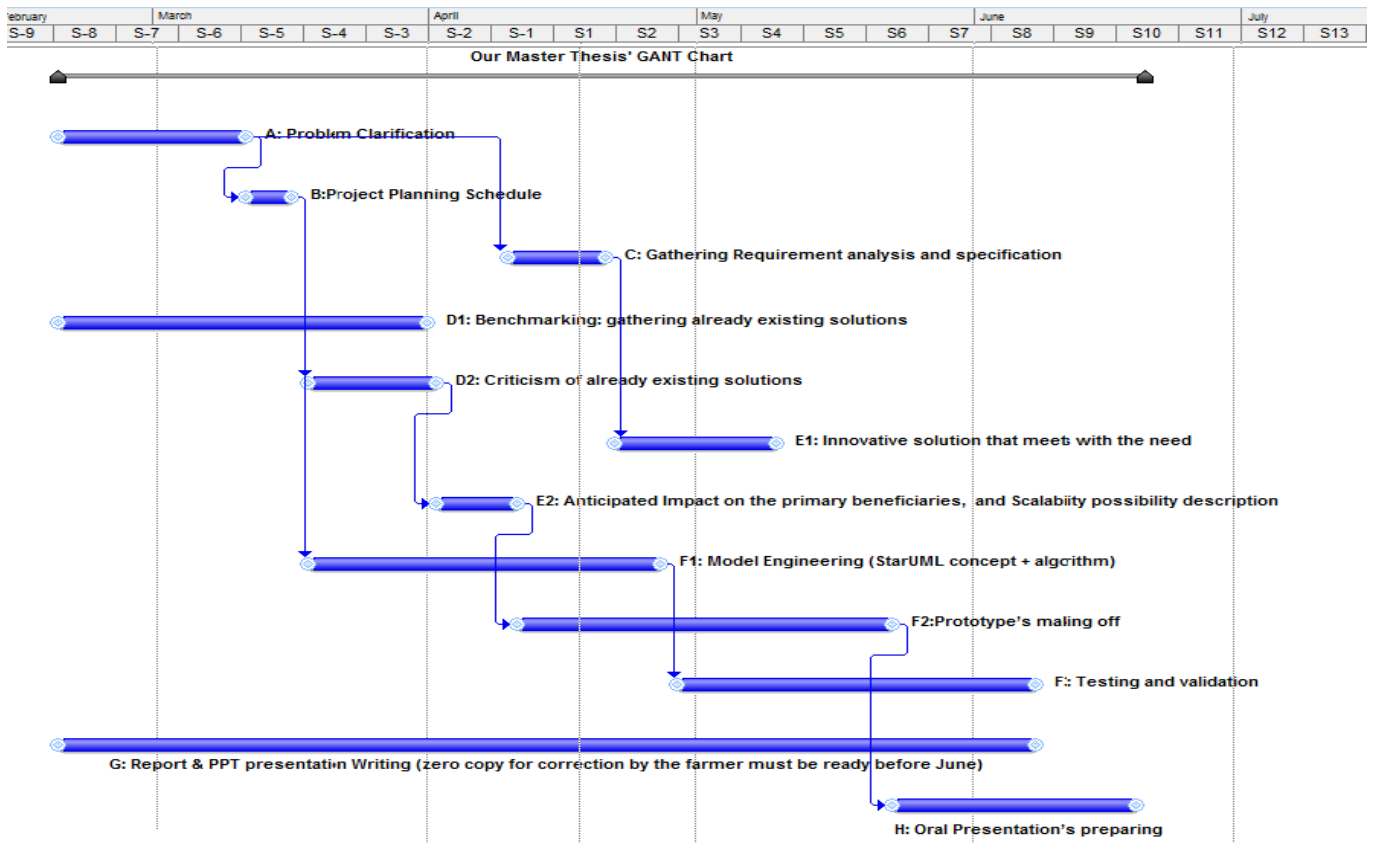

Fig. I. i Gantt Diagram

A Gantt chart is a type of bar chart, developed by Henry Gantt in the 1910s, that illustrates a project schedule. Gantt charts illustrate the start and finish dates of the terminal elements and summary elements of a project. In order to well prepare, draft and plan our project, we have created a Gantt chart, to break it down into smaller tasks. This schedule will be a tool that should be updated during the advancement of our project, whilst respecting our deadline.

3.3-Needs Analysis:

Adding to the artefacts a sensor, will allow us to capture its geographical position, using GM862-GPS as a module. Creating a little integrated circuit, connected with a server through a global positioning system (GPS), we will be able to detect the stolen pearl location, track it, and then get it back. As a result, we will protect our history treasures against theft.

3.4-Thesis' Target Audience:

The target audience for our antitheft sensor's prototype, include the precious and priceless wide range of items that are shown on museums, such as history documents, landmarks, artefacts of all kinds, art masterpieces like portrait and mosaic, archaeological objects, sculpture, which are characterised by scientific, artistic, cultural, or historical importance.

3.5- process used to develop a Geo-Antitheft prototype:

If we add our prototype on the back side of the artefact (mosaic, masterpiece, sculpture...), and once it exceeds the museum's internal security system, the geographical localisation will make us able to detect its position and protect the temple of our cultural heritage against smuggling.

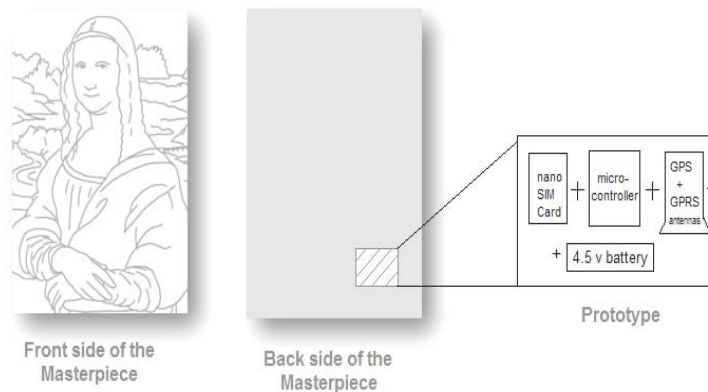

Fig. I. ii: Prototype

For the embedded system, our prototype will be composed of a micro-controller that will be a programmable pic, on which, we will set up the code, developed on python, a Subscriber Identity Module SIM, support, on which we will add a nano sim card that will warrant at the same time the geolocation and the alarm management, two antennas: GPS, GSM and a 4.5 battery, from which the module will consume just 3v after filtering.

All our masterpieces will be detected through geolocation, then, their geographic position coordinates will be sent to the monitoring station.

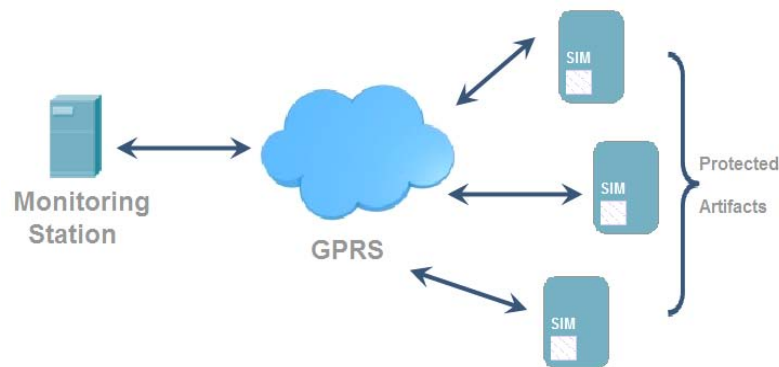

Fig. 1. iii: General Synoptic

4-Thesis Outline:

This master's thesis is divided into seven chapters. The first one presents a general introduction of the topic, the context, the problem statement and the objectives of this work. The second one is about Benchmarking through gathering the already existing solutions, in order to criticise their negative point of view, to finally suggest as a solution our innovative prototype that will meet our main objective. The third chapter provides an architectural study of the geolocation process. The fourth chapter clarifies our module GM862-GPS as a smart geo-antitheft solution for immobile masterpieces. The fifth chapter is about our chosen tools and technologies to realise our project. The sixth chapter, which regards the model engineering part of our master thesis, will include the conception diagrams, such as case Sequence and activity diagrams and the algorithm. On the seventh chapter, the prototype's making off, we will convert our conception into a source code, using Python as a programming language, which is characterized by its own integrated development environment: python, and we will use the 3.3/64bits version that meets with our operating system: windows 7. Finally we will terminate our master thesis by a conclusion and perspectives, a bibliography and some appendices.

Chapter II: State of the Art

1-Introduction:

Nowadays, the antitheft security field is becoming more and more fundamental. In order to protect the priceless and irreplaceable history of any country, all the Museums are using several antitheft security ways, but all of the yet existing systems are limited to the minimized scope of the museum.

Having done extensive research, we have not found any way dedicated to detection through geolocation, which proves that our idea is an innovation in the antitheft security field.

The state of the art presented in this chapter is divided into four parts, in which we define the different security solutions already functional, aiming to make the most exhaustive analysis about them, in order to properly identify the encountered difficulties.

During our graduation project, we have done our utmost, hoping that our prototype will represent a solution to ensure the geolocation of the stolen goods, thus we will be able to protect our priceless history.

2-A comparative study of the already used museums' security systems:

In order to protect each country's cultural heritage against theft, we have to combine three different defending modalities: physical, electronic and human [1.4]. These means always complement one another, and are used in order to prevent or delay the process of the theft.

2.1-Human defending modalities:

Museum protection duties never stop. The handover from night to daytime duty should be carried out according to agreed on procedures, in an ordered and secured manner. That is why human security instructions are generally applied in most circumstances, in addition to the other mechanic and smart security systems.

Security agents' daily task is to inspect all artefacts on display and check that all are counted and secured [1.3]. In case of accidentally moved artefacts, or if the security agents find them in a different position, they are immediately called to alert the police and / or the masterpieces' shelter committee.

And until the police agents come, the security agents have got many substantial tasks to do such as:

- Location and state of fire alarm buttons.
- State of all internal phones to guarantee that they are in working order
- Carefully identify visiting scholars and third parties, before granting a visitor pass.
- Closely monitor all loading and unloading operations.
- Check all intrusion detector devices by observing the blinking light reaction to the agent's movement.
- Monitor cleaning operations and occasionally check contents of trash bins

2.2-Material defending modalities:

From the discovery of the thief's attempt to the capture, the museums' security process includes five stages: detection, transmission, alarm, alert and response.

In this context, various security equipments are intended to prevent or delay the process of the thief by using mechanical tools such as locks, shutters, automatic windows or burglar alarm pains and others...

Detection hardware regard warning devices that are running without human intervention (except, naturally, for the control). They are very different and they use a wide range of physical phenomenon. Their structure and function are often kept secret by the manufacturers and their principle is always the same: detecting causes, acting in the installation, alteration not triggering the alarm. On Fig. II.1 which symbolizes a museum's building safety system; we will quote some detection hardware, and then define every component's functioning and usefulness.

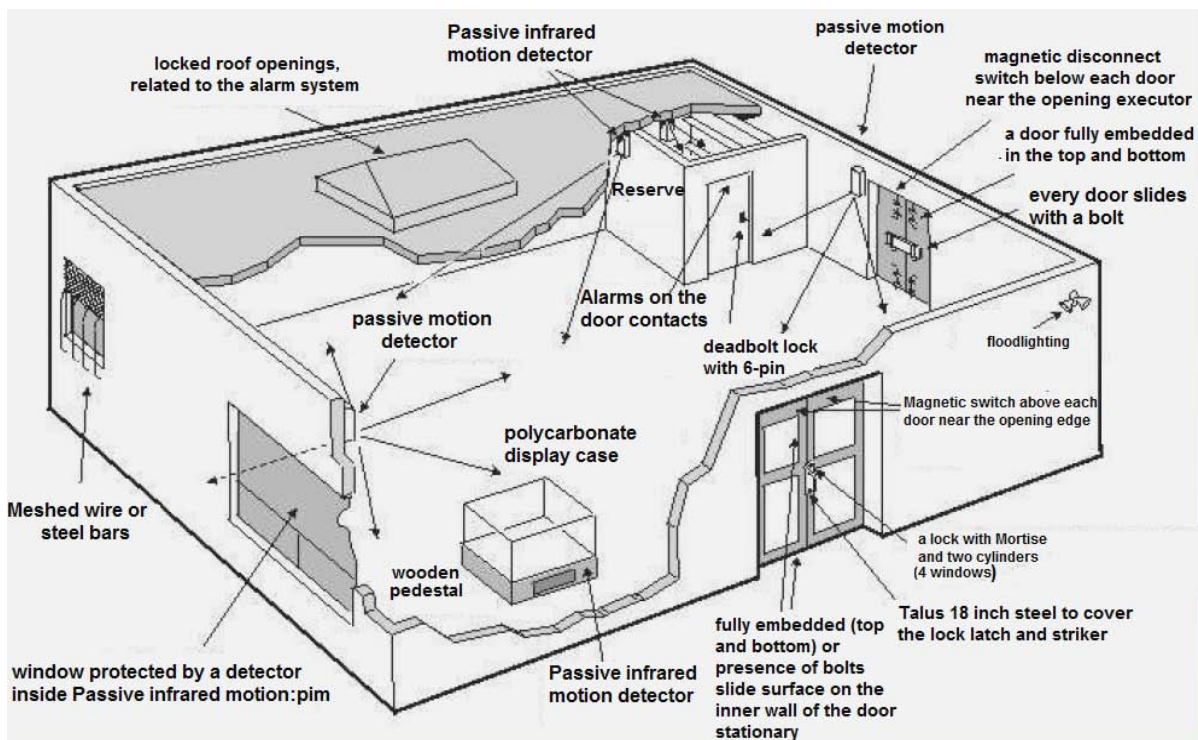

Fig. II. i: Museums Physical Security System Overview

a-The lock:

A **lock** is a mechanical or electronic fastening device that is released by a physical object (such as a key, key card, fingerprint, RFID card, or security token) or secret information (such as a key code or password), or combination of more than one of these.

In museums, locks are used to secure closing showcases, in which artefacts are shown, in addition to the polycarbonate display case.

b- Pedestal with polycarbonate display case:

A pedestal [2.5] is an architectural support or base, as for a column or statue which serves as a foot or support, particularly for a piece of sculpture, a monument, or other work of art, specifically in *museums*, an insulated base or support for a column, a statue, or a vase. It consists typically of a base or foot, a die or dado, and a surbase, cornice or cap. The majority of the pedestals are built with the Polycarbonate, which is a hard and transparent thermoplastic, highly resistant to impacts. This Burglar glass resists to destruction of a glazing by means like a hammer or a hatchet.



Fig. II. ii: Pedestals with polycarbonate display cases and locks

2.3-Electronic defending modalities:

Electronic protection consists of three concentric levels: perimetric (door opening), volumetric (people's presence) and centric (the artefact). In this part, we will define with details some of the electronic defending modalities' examples.

a -Sounds' detectors:

Sounds produced in a specific area are picked up and analysed by an electronic system which sets off an alarm according to the volume and the characteristics of the detected sound. **Microphones** are first placed in the premises or the space to be guarded and then connected to a selective amplifier, which reacts only to certain frequencies that correspond to the sounds emitted by burglars' tools (punches, saws, hand-drills, blow-lamps, sledge-hammers, etc.) and to certain noises (rustling of paper, scraping, breaking of glass, etc.), microphones can be adjusted according to the layout of the premises and sets off an alarm when the volume and characteristics of the selected noises reach a certain level; but it is unaffected by surrounding outside noises (road traffic, trains, underground railway, etc.). They really symbolize effective and sensitive means of detection, easily installable, characterised by modest and easily concealed dimensions. Supervision and control can be effected at a distance by listening to with head-phones or a loudspeakers.

c -Passive Infrared Detectors:

A passive infrared detector [2.11] can scan the thermal radiation emitted by any mammal, whose body has a temperature above the 0 absolute infrared products. The man has an external temperature of around 37 ° C, thus emitting an infrared radiation, whose wavelength average is about 10 micrometer. This wavelength is "below" the red (0.65 micrometer = 650 nm for red lasers)



Fig. II. iii: Passive Infrared Detector

A passive infrared detector performs some security functions such as distinguishing the radiation emitted by a human or an animal from that emitted by objects, or defining whether the transmission source of the radiation is fixed or moving or even transmitting information in the context of detection (moving body heat).

PID is used to perform defining strange movements during night duty, then to capture thieves before they leave the museum.

The Infra Red Detector is a part of the motion detectors family, mainly varying between the following types of sensors:

- Large angle detectors with opening angle between 90° and 180° and a nearly 20m detection range
- Long-range sensors which opening angle is very small (a few degrees) and a 60m detection range

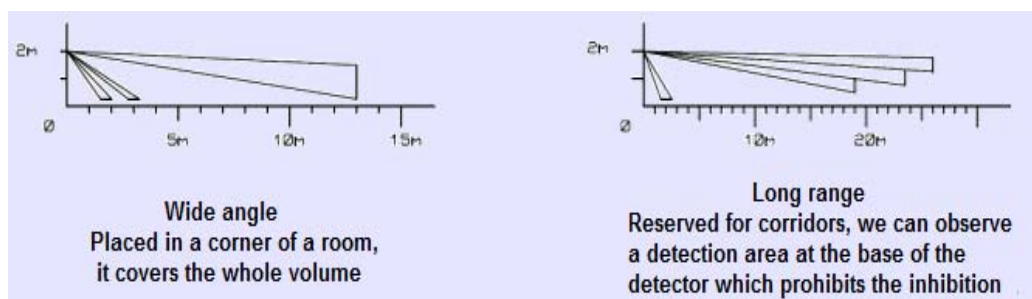

Fig. II. iv: The PID's sensing lobe

4- Closed-circuit television CCTV:

One or more television cameras, focusing on the points or areas kept under supervision are connected with one or more receivers situated at a control point some distance away. They may be fixed or operated by a remote control to scan an area or object of considerable dimensions. Both indoor and outdoor operations are possible, although a minimum amount of light is always required. A wide variety of cameras is available (conventional, industrial, waterproof, tropical models, etc.) for use under various types of atmospheric conditions (acid, saline, tropical, polluted, etc.). Some are specially designed to withstand vibration and shock, high/low temperatures, radiation, etc. Telephoto or wide-angle lenses can be used to increase camera range or field of vision.



Fig. II. v: CCTV Running

CCTV are used to supervise all the museums' departments where are exhibited priceless articles, in order to be up to date with what masterpieces have undergone because they are suitable for use in most circumstances and it is noteworthy that compact cameras do not attract attention, then, observers and officials can watch in safety from outside the protected or danger area. Any decision required can be made immediately on the basis of direct observation without need for investigations and reports. Extremely effective means of protection when used in conjunction with defence, alarm or remote-control systems. A single observer can keep watching on several different points or areas with two or more cameras.

3- Benchmarking: Criticism of already existing solutions:

In addition to the common downsides of indoor limited security systems, every antitheft solution already mentioned has got its own disadvantages, among these, we can quote:

3.1 -Human modalities downsides:

Human defending modalities are related to the danger of corruption or complicity, the difficulty of finding a replacement for anyone unexpectedly absent (e.g. through illness) or the danger of negligence arising from over-familiarity with the establishment.

3.2- Material modalities downsides:

Locks are easily broken or destroyed, and the electrified barriers are sometimes incompatible with other essential safety measures (evacuation of staff or public in the event of fire or other emergencies).

3.3- Electronic modalities downsides:

The electronic defending modalities such as sound detectors cannot be used near sources of violent noise or if the premises or space to be guarded contain sound-producing equipment or initial difficult tuning

(background noise), or regular checking and adjusting. In addition, with passive infrared detectors, photo-electric cells can be rendered ineffective by excitation from another source of light (if the beam is not modulated), besides, the use of mirrors may lead to false alarms or defective operation, alarm can be set off by animals, night-flying insects, etc. And for the CCTV, we can quote as a downside the minimum of light required for operation of cameras, and the effectiveness depends on continuous presence and vigilance of guards.

3.4-Analysis:

There are many other techniques and methods used to prevent and detect theft and raids; in our comparative study, we have not mentioned all of them, being limited to the security solutions applied on Tunisian Museums. In table 2, we summarise the negative points of the already existing solutions, knowing that, in addition to every issue's own downside, all of them are sharing a common difficulty: their security is limited to the museums indoor, and if a thief has exceeded all of them, the stolen artefact could neither be geolocated nor brought back to the museum easily.

Although international museums contain many other security tools, they cannot follow stolen masterpieces once they are taken outside the museum. Thus, geo-locating stolen masterpieces will be easy and so helpful, in order to avoid this gap.

4-Smart Geo-Antitheft Solutions are limited to mobile articles:

Two decades ago, intelligent solutions for security against theft already existed and have been booming. From then on, we will quote in this part, two Smart Geo-Antitheft solutions, to explain the way they run to geotag them once they are stolen.

4.1- Vehicles Anti-theft systems:

The Antitheft GPS Tracker [2.13] is a complete product that allows locating the vehicle at any time in case of theft or carjacking. Anti-theft systems have protected millions from the liability of a stolen vehicle as they form a central monitoring which locates the vehicle and immobilizes it in case of theft, with a simple SMS.



Fig. II. vi: Vehicle GPS Tracker

Once connected, the tracker must be set by SMS, with the phone number to which it will send its location information. In use, a simple SMS will be received, indicating particular time, date, speed, latitude and longitude of the tracker. By entering these details on the supplier's tools, the vehicle owner will be able to precisely give its location

displayed on a Google map. In case of theft, an SMS command, sent to the tracker, will prevent the engine as soon as the latter will be cut and the engine will not start until the tracker has not received another SMS to 'unlock'.

4.2- Smartphones geolocation antitheft:

Smartphones are intelligent and sensitive products that need to be secured. So, in addition to the soft protection against malware, viruses and cyber threats, we also protect them against risk of loss or theft via geolocation. Kaspersky Mobile Security [2.7] includes technology for optimal protection. In case of loss or theft of an Android Smartphone, Kaspersky Mobile Security allows the processor to geo-locate it, due to remote access tools such as locking and location, blocking access to the device and helps the owner to locate his lost or stolen phone, deleting data (customer's personal information), alarm activation on the lost or stolen phone, Mugshot: photography unauthorized users and send photos to owner, locking the Smartphone if SIM card is replaced, secret code prevents unauthorized uninstall of Kaspersky Mobile Security, alarm management functions on the Web: control functions for Internet theft.

4.3-Conclusion:

Vehicles and smartphones tracings are two smart security tools, which can easily prove their real efficiency if they are used to protect smart articles against theft. But these solutions are only applicable on mobile items such as vehicles and Smartphone. Intelligent e-security innovators have always treated only smart mobile articles. This was easy because such articles are already equipped with power, sim card, and geolocation applications. E-security solutions have never been used in order to protect immobile articles, especially the priceless ones that reflect a country's history, such as masterpieces, artefacts, mosaics... That is why we aimed to use our geo-antitheft prototype.

5- Innovative solution that meets with our need:

On the beginning of our study, and to get an understanding of the already existing competitive products, we have done a benchmarking, which has been performed in different ways, such as literature study, analysing security tools or visiting some museums (either virtually on their websites or really—we went to Bardo museum-). We have done this study in order to be informed about already existing security solutions, which led us to find some weaknesses that we will try to discard. As a solution, we suggest a little innovation, which boils down on protecting the precious masterpieces against theft, using geolocation as a facility.

6- Anticipated Impact:

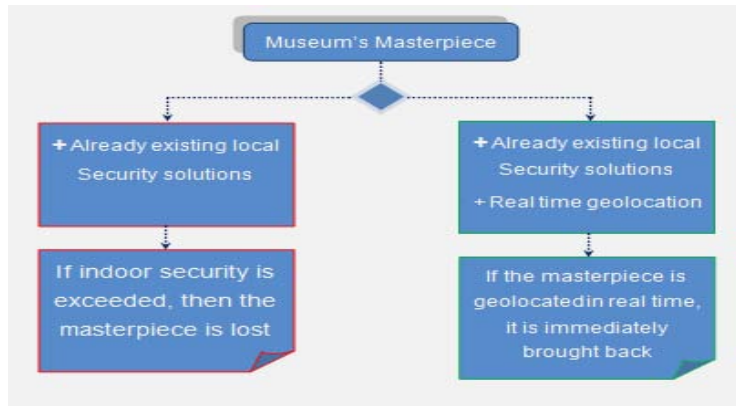

Fig. II. vii: Our Prototype's Aim

The aim of our work is to design and implement a new antitheft security prototype through a real time geolocation. To achieve our goal, we studied the various existing methods namely human, electronic and physical ones. This meant us to find that their disadvantage is summarised in being limited to the scope of the museum and once a masterpiece is stolen, it can never be located, which makes its recovery almost impossible. Through this study we identify as a solution, a useful concept to geo-locate any stolen property, thereby facilitating and reducing its recovery by using a module and an application manipulating spatio-temporal data. A model GM862-GPS, for which we present a prototype, would be an appropriate solution which, when equipped with a nano-sim-card, GPS and GSM antennas then added to the artefact, will make us able to capture the stolen good's geographical position in real-time, and get it back easily and quickly

Once the functionality of the prototype is confirmed, we will replace it by smaller size kits that make it more flexible and economic energy consumer standpoint. It will be even possible to swap it into one security chip in a form of a sticker with bar code on the opposite side. By this way, we will be able to reduce the contraband risk and protect our precious and priceless history.

Chapter III:

Architectural study of the geolocation process

1. Tracking Technologies:

Tracking (also called geolocation or geo-referencing) is a process used for positioning a person or an object on a plan or a map using geographical coordinates [2.1]. This operation is performed using a terminal which is able to be located through a Global Positioning System by a GPS receiver or other techniques, then publishes either in real or deferred time its geographic coordinates (latitude/longitude). The recorded positions can be stored in the terminal to be retrieved later, or transmitted in real time to a geolocation software platform. The real time transmission requires a terminal which must be equipped with telecommunication means, such as GSM, GPRS, UMTS, radio or satellite, allowing sending the position at regular intervals. This will allow us to visualize the position of the terminal in a card through a geolocation platform, which must always be accessible from the internet.

We can subdivide the tracking technologies in two aspects: indoor and outdoor. In this chapter, we will define these two angles, than quote some examples, and finally we will justify our choice of GM862-GPS module to be used as a smart geo-antitheft tool.

1.1-Indoor positioning systems:

To wirelessly locate objects or people inside a building, we can use a network of devices. Once they are combined, they can mold an indoor positioning system, which relies on nearby nodes, specified by their already known position. This latter requires at least three independent measures per target. Thereby, this process has the advantage that no costly hardware installations are necessary inside a building if WLAN is already available. Indoors, cellular coverage may become less powerful while the GPS becomes powerless. Therefore, the right solution lies in implementing in museums some wifi terminals, transmitting with close intervals in order to transmit wifi range close and emit a wireless signal which will be captured by the mobile allowing its location even indoors.

a -Triangulation system:

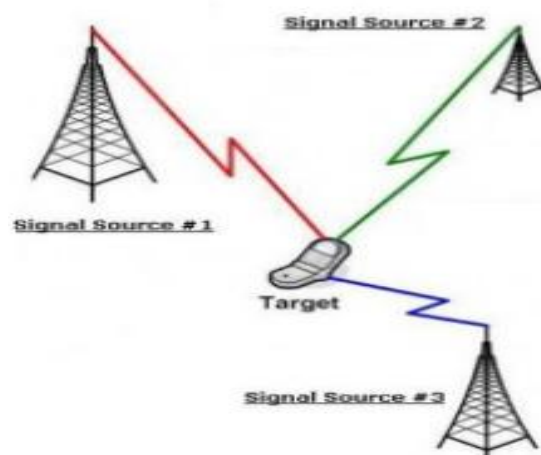

Fig. III. i: Triangulation System

The triangulation system [2.1] is based on the crossed processing information coming continuously from three relays transmitter /receiver which change progressively terrestrial antennas used by the mobile user while moving. This system requires the installation of an application on the SIM card of the mobile phone.

b -Cell-ID:

System identification cell [2.1] presents the simplest and least expensive geolocation technology. When the user is in a network covered area, he is located through the cell identification to which belongs the antenna and by which the communication is transmitted. And although this location is fast (it consists of two or three seconds), it is not very accurate, since it locates a person in more or less 250 meters in an urban area, where the network is dense against some ten kilometers in rural areas.

c -Near Field Communication:

NFC [2.9] is a wireless communication technology, characterised by its short-range and high frequency at the same time. It allows an information exchange between peripherals. NFC technology extends ISO/CEI 1443 norm, which standardizes the proximity maps, using the radio-frequency identification, combining on the same peripheral a smart card with a card reader

NFC is used to enable the communication with:

- Electronic ticketing and some contactless infrastructures such as the public transport approver or the shop payment terminals
- Automatic car locking on the departure of the NFC device
- NFC Key for houses, hotel rooms, offices...

With a screen, a keyboard and an internet connection, these NFC devices have potential uses by promoting interactions between machines and objects.



Fig. III. ii: NFC application Fields

d -Radio-Frequency Identification:

RFID is a method to memorise and get a remote data recovery. RFID tag, also known as RFID transponder, are small objects, such as self-adhesive labels that can be pasted or embedded in objects or products or even implanted in living organisms such as human body or animals. RFID tags include an antenna

associated with an electronic chip which allows them to receive and respond to requests sent from the radio transceiver. These chips contain an identifier and eventually some additional data.

This identification technology can be used to identify people (being integrated into passports, travel card, credit cards known as contactless card), objects (with a bar code), also known as electronic label or domestic carnivores (such as dogs, cats and ferrets) which RFID is mandatory in many countries, is implanted under the skin. This is called as a subcutaneous microchip, which size is near to a rice grain's one.

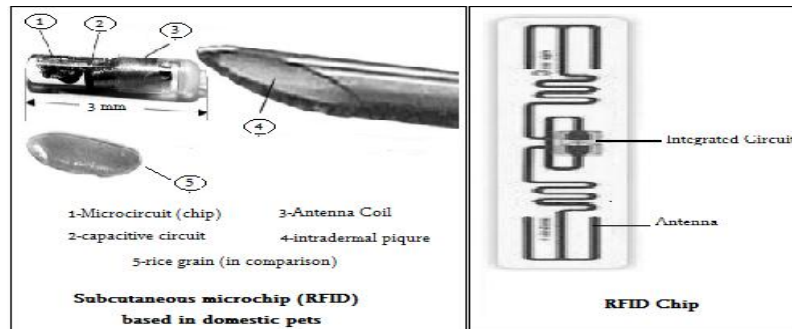

Fig. III. iii: Subcutaneous Micro Chip & RFID Chip

e- Analysis:

All the already quoted indoor positioning systems may smartly play a very clever antitheft security role on museums, in order to save and protect every country's history for next generations. They can provide an adequate but limited internal security. As soon as the stolen item is worn on the outside, we can no longer locate it. That is why we have to study the interest and the possible ways for the outdoor protection, which would be insured by geolocation.

1.2-Outdoor Positioning systems:

Outdoor Positioning Systems are used to automatically identify and track the location of objects or people in real time, in order to be informed about location information which may include speed, direction, or spatial orientation of the tracked object or person.

In our studied case, the outdoor geolocation may play a very interesting role, allowing us to track a stolen masterpiece once it is taken outside the museum, and this will help us to easily and quickly find it, to avoid the risk of smuggling the precious stolen pearl outside the country's borders during the investigations' period. In this case, the outdoor positioning systems can be used as a geolocation method to track and position in real or delayed time, individuals or fleets equipped with radio transceivers and moving in a geographical area bounded by their activity, using their geographic coordinates. This operation is performed using a terminal which is able to be located by a technique (we will present some examples) and publish (in real time or with a delay) their geographic coordinates (latitude / longitude).

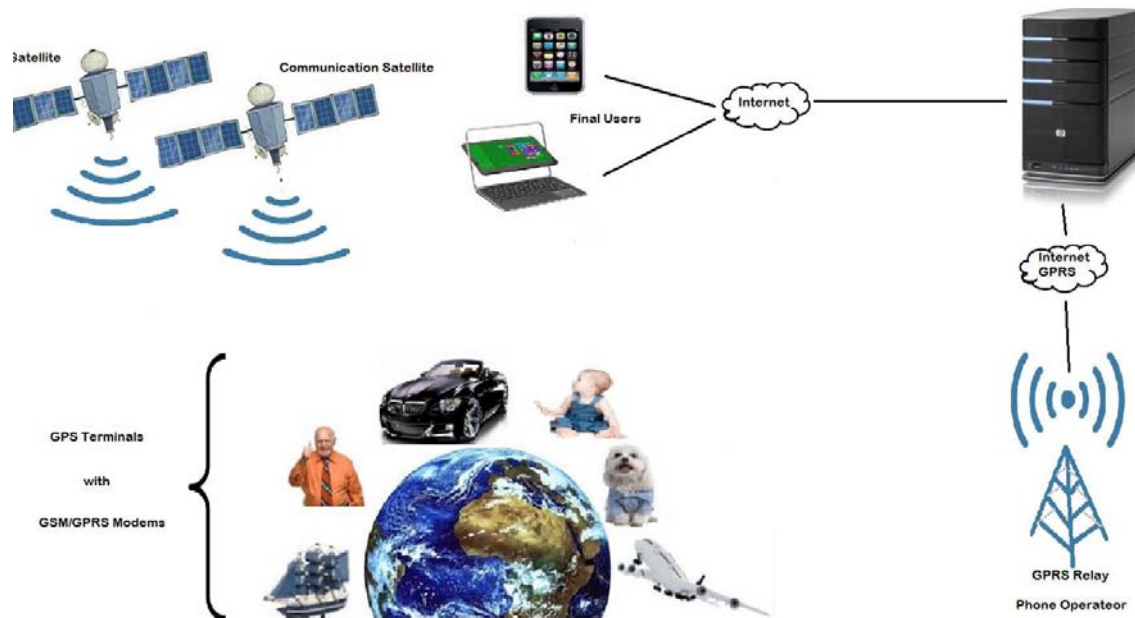

Fig. III. iv: GPS Geolocation Principle

The Global Positioning System [2.6] GPS is a system for positioning or locating which operates with distance measurements between the receiver and several satellites. This system allows to know the position of a person or an object on the globe by a sum of geometric calculations. A GPS receiver is purely passive and emits no information. Many applications requiring precision need the use of GPS in differential mode, that is to say, that we couple the received signals by the receptor for which we want to know the position on a known fixed point. GPS is a tool used to quickly and accurately locate important information. This system is used for fleet management or tracking stolen vehicles monitoring or even the transport of dangerous goods with a route optimization.

1.3- Mobile communication systems

The recorded positions can be stored in one terminal then extracted and transmitted in real time to a software geolocation platform. This real time transmitting requires a terminal with a telecommunication tool such as GSM, GPRS, UMTS, or satellite radio enabling it to send the position's coordinates at regular time intervals. This allows visualizing the terminal position in a map through a geolocation platform most often accessible from the Internet.

a -Global System for Mobile communications

The principle is to locate a person or a vehicle equipped with a GSM chip, using the nearest base station to where he (or she) is, or more accurately by performing a triangulation from nearby antennas.

Base stations operators (antennas) exchange signals with the mobile located in their areas of radio coverage, also called radio cells (Cell-ID) [2.8]. The geographical area covered by each cell is itself known by the operators, who can determine the approximate location of a user (a few hundred meters in urban areas and up to several kilometers in rural areas).

b-General Packet Radio Service:

GPRS is a new technology that allows to significantly increase the GSM data rates. This is the second generation GSM network [2.10]. It will allow us to send and receive data packets from a mobile phone with a theoretical speed of 115 Kbits/s, which is almost three times the rate of the current GSM system. GPRS is called 2.5Generation network because it uses the same frequency range as GSM.

c-Universal Mobile Communication System

The Universal Mobile Telecommunications System (UMTS) is a third generation mobile cellular system for networks based on the GSM standard. Developed and maintained by the 3GPP (3rd Generation Partnership Project), UMTS uses wideband code division multiple access (W-CDMA) radio access technology to offer greater spectral efficiency and bandwidth to mobile network operators.

UMTS specifies a complete network system which uses, covering the radio access network (UMTS Terrestrial Radio Access Network, or UTRAN), the core network (Mobile Application Part, or MAP) and the authentication of users via SIM (subscriber identity module cards).

2-Some commercialised tracking technologies examples:

In this part of our third chapter, we are going to quote some examples of tracking technologies by classifying them in two categories: indoor and outdoor.

2.1-NAO Campus:

Worldwide, indoor geolocation service is such available that more than 4 million square meters indoor are covered. The service is available on many Smartphones trademarks. Indoor tracking is a hybrid technology that combines GPS, Wifi, Bluetooth Low Energy and inertial sensors to adapt to all the places and networks.

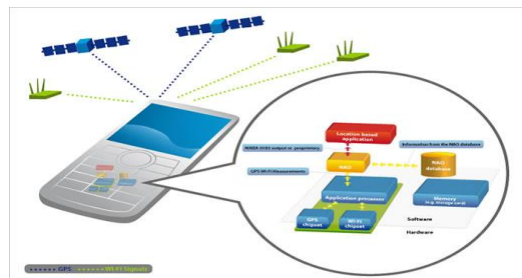

Fig. III. v: NAO Campus

NAO Campus [2.14] aims at the mobile devices like smartphones, PDA, PND, laptops, notebooks, Touchpads... and also professional terminals like EDA and specific terminals. NAO Campus requires no modification in smartphones; it produces work by combining GPS, Wi-Fi signals and cartographic data. They are aimed at devices incorporating GPS (or A-GPS) and Wi-Fi, or Wi-Fi terminals purely

2.2-G-Track:

As we said before, all the already invented tracking technologies were aimed only at mobile articles, in order to monitor and protect: travels by ships or planes, babies, sick or elderly who really need to follow them and antitheft for cars and trucks...



Fig. III. vi: G-Track

System Gtrack GPS [2.15] Tracker is a free subscription. The tracker Gtrack works with a single SIM card, even pre-paid, no needed subscription to a telephone platform to locate your vehicle. The Gtrack is compact and ideal for drawing vehicles. This system offers a number of advanced features in basic configuration with only 3 wires to be connected to the vehicle. The Gtrack can be installed on a car, utility truck, motorcycle or boat, so just for mobile articles.

3-Conclusion:

The various tracking technologies above mentioned, are already used for the protection of the mobile goods and people (babies, sick or elderly), which enhance the interest of the smart techniques, that can be used in order to secure them through geolocation.

And since the positioning method is used to protect only mobile items, why don't we migrate this protection to the masterpieces that are at once motionless and of high value.

Having done the previous study about indoor and outdoor tracking technologies, we decided to combine the use of GPS and GSM technologies, which allow us to geolocate the stolen masterpiece, and get information about its geolocation by an SMS which is sent to the monitoring station. This is how to facilitate its location in order to get it back rapidly.

We have chosen the GM862-GPS component, to do the mentioned combination, in order to be able to track the stolen masterpieces, having been informed about their place would help us to easily save these priceless articles.

Chapter IV

Our Geo-Antitheft solution for immobile masterpieces

1-Introduction:

In this chapter, we will describe our innovative geo-antitheft solution by mentioning its composition, describing its performance and the way it will work, in order to easily track the theft artefacts, and that is what will make the stolen masterpiece recovery easier and faster.

2 -Definition:

GM862-GPS [1.5] represents one of the GM862 modules family, which combines the access to digital communication services in GM 850, 900, DCS 1800, PCS1900 MHz networks. It is the only GM862 version which contains an additional key feature of the integrated GPS receiver (GM862-QUAD and GM862-QUAD_PY have not got an integrated GPS receiver). In addition to the 20 channels GPS receiver, GM862-GPS provides many features such as Voice, Circuit Switched Data transfer, Phonebook, SMS, four bands GSM capability, hot removal sensing on board SIM Reader, GPRS Class 10 and battery charger circuitry.

Moreover, like the GM862-QUAD and QUAD_PY models, the GM862-GPS one integrates the "EASY SCRIPT" functionality which is a PYTHON engine script interpreter allowing self-controlled operations. To become a final antitheft tracking technology, GM862-GPS needs our script to be developed and run through the *easy script* feature.



Fig. IV. i: GM862-GPS Module

The GM862 is specifically designed and developed by Telit for OEM (Original Equipment Manufacturer) usage and is dedicated to process portable data, voice and telemetric applications, such as: Telemetry and Tele control, Security systems, Vending Machines POS terminals Phones and Payphones Return channel for digital broadcasting and applications, where the external application processor can be replaced by the PYTHON engine provided by GM862-GPS. These are common applications for the GM862-QUAD, GM-862-QUAD-PY and GM862-GPS. This latter, in addition to the yet mentioned specifications, is characterized by automotive and Fleet Management applications, and position reporting and tracking and that is what will make GM862 available for tracking stolen masterpieces.

Briefly, we can say that the GM862 model supports the following functionalities: Easy GPRS (AT driven embedded TCP/IP protocol stack), Easy Scan (full GSM frequency scanning), JAMMING DETECT & REPORT (detect the presence of disturbing devices), CMUX, SAP (SIM Access Profile) and Multisocket.

From the interface point of view, the GM862-GPS provides the following features: Full RS232 UART, CMOS level (ASCO) interface for AT commands (Autobauding from 1.2 up to 115.2 Kbps and fixed baud rate from 300 bit/s up to 115.2 Kbps), two wires RS232, CMOS level (ASC1) for PYTHON debug, SIM card interface, 3 volts and 1.8 volts, 13 x GPIO ports (max), 1 x A/D converter, 1 x buzzer output, 1 x led status output indicator.

3-Specifications:

3.1-Features:

From the interface point of view, the GM862-GPS module provides some features such as:

- A CMOS level interface (ASCO) for AT commands, with an auto-bauding from 1.2 up to 115.2 Kbps, and a fixed baud rate from 300 bits/s up to 115.2 kbps.
- Two wires RS232 and CMOS level (ASC1) for PYTHON debug
- One analogical/digital converter
- One Led status output indicator
- One buzzer output

Thirteen GPIO (General Purpose Input/Output) ports, which are generic, pin on a chip whose behaviour (including whether it is an input or output pin) can be controlled (programmed) by the user at run time.

3.2-Interface connectors on GM862-GPS:

The Telit GM862 Family composed of GM862-QUAD, GM862-QUAD-PY and the GM862-GPS modules have the following common interfaces: GSM antenna connector, Board To Board Interface connector, SIM Card Reader, and GPS antenna connector, which is only on the GM862-GPS module.

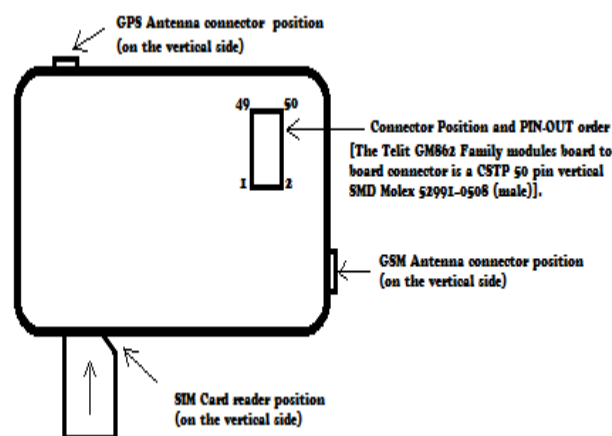

Fig. IV. ii: GM862-GPS Connectors

3.3- Antennas:

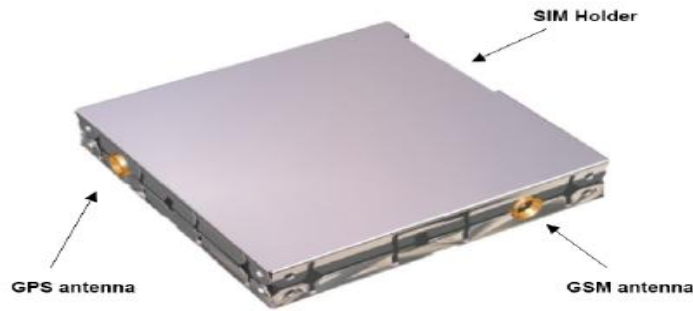

Fig. IV. iii: GSM and GPS Antennas

To be able to geolocate any artefact theft, we have to use the GSM and the GPS antennas which would fulfil the following requirements:

Antennas	GSM	GPS
Frequency Range	Depending by frequency band(s) provided by the network operator	GPS L1 (1575.42 MHz)
Bandwidth	80 MHz in EGSM 900, 70 MHz if GSM 850, 170 MHz in DCS,140 MHz PCS band	Bandwidth +-1.023 MHz
Specification	we shall use the most suitable antenna for the band(s) provided by Tunisie Telecom	GM862-GPS Transceiver module includes a 50 Ohm MMCX connector for the GPS antenna
Power consumption	Power off current (typical) <26 μ A Stand-by current < 17 mA Operating current in voice channel <200mA Operating current in GPRS class 10 <370mA	55mA is the typical current consumption of the GM862 GPS part, including 35mA for the GPS hardware and 20mA for the antenna LNA

Table 1: GSM and GPS Antennas' requirements

3.4- SMS and Real Time Clock and Alarm:

SMS:

The Telit GM862 Family modules support the following SMS types:

- Mobile Terminated (MT) class 0 - 3 with signalling of new incoming SMS, SIM full, SMS read
- Mobile Originated class 0 - 3 with writing, memorize in SIM and sending
- Cell Broadcast compatible with CB DRX with signalling of new incoming SMS

Real Time Clock and Alarm:

GM862 Family modules support the Real Time Clock and Alarm functions through AT commands, Furthermore an alarm output pin (GPIO6) can be configured to indicate the alarm with a hardware line output.

3.5-GPS module usability for Tracking:

The GPS Module features represent some specifications that would make the GM862 effectively useful for tracking the stolen masterpieces, to which it will be associated. Due to the SIRFstarIII™ single chip GPS receiver, included in GM862, the real-time location in urban area and wherever a high sensitivity acquisition is needed becomes easily attainable. As main features of such GPS receiver, we can mention:

Sensitivity: The GPS module is characterised by its High sensitivity for indoor reception, which makes its tracking signal strength vary significantly (up to -159dBm).

TTFF: Time To First Fix (TTFF) is a measure of the time required for a GPS receiver to acquire satellite signals and navigation data, and calculate a position solution that we call as a fix. And the GPS module is characterised by an extremely fast TTFF's at lost signal levels

Supported criteria: The GPS module supports more than 200.000 effective correlations, 20Channel GPS L1 1575.42 MHz, accuracy less then 2.5m, low power consumption and dedicated GPS AT commands.

GPS Driving: The GPS functions are driven from the GSM BB processor through a dedicated AT command set available in a separated specification.

GPS NMEA: NMEA 0183 is a combined electrical and data specification for communication between marine electronic devices such as echo sounder, anemometer, autopilot and GPS receivers. It has been defined and is controlled by, the U.S.-based National Marine Electronics Association. The GPS data stream is available on the connectors' pins 35 and 41: TX-GPS and RX-GPS in RS232 format 8N1, 4800bps (9600, 19200, 38400 and 57600bps are also available). Among the GPS NMEA sentences [2.12] we can quote:

- **GLL** for Geographic Latitude and Longitude,
- **GGA** for Global Positioning System fix data which provides a 3D location and accuracy data,
- **VTG** for course over ground and ground speed
- **GSA** for GPS DOP and active satellites
- **RMC** for recommended minimum specific GPS data.

Thereby, these NMEA sentences can be used on our geo-antitheft prototype to inform us about the geographic position of the stolen masterpiece, and even track it continuously.

3.6- Security:

The local security management on GM862 is possible through the lock of the Subscriber Identity module SIM and security code request at power-up. The activation and deactivation of the numbers stored in phone book are supported, FDN, ADN and PINs too. The extension at the PIN2 for the PUK2 insertion capability for lock condition is supported too.

3.7- Converter-Multiplexer (CMUX):

CMUX is a multiplexing protocol, implemented in the Telit module that can be used to send any data such as SMS, fax and TCP data. The Multiplexer mode enables one serial interface to transmit data to four different customer applications. This is achieved by providing four virtual channels using a Multiplexer (Mux). This is especially advantageous when a fax/data/GPRS call is ongoing. Using the Multiplexer features, e.g. controlling the module or using the SMS service can be done via the additional channels without disturbing the data flow; access to the second UART is not necessary.

Furthermore, several accesses to the module can be created with the Multiplexer. This is of great advantage when several independent electronic devices or interfaces are used. To access the three virtual interfaces, both the GSM engine and the customer application must contain Mux components, which communicate over the multiplexer protocol. In Multiplexer mode, AT commands and data are encapsulated into packets. Each packet has channel identification and may vary in length.

3.8- Sim Card Reader Properties:

On our Geo-Antitheft prototype, a SIM card will be added to every geo-antitheft prototype, to send to the monitoring station an SMS which provides information about the GLL. Our GM862-GPS has got an internal built-in SIM card reader that allows also hot removal of the SIM sensing. Therefore, the SIM can be extracted and reinserted while the module is still on, so there's no need for an external SIM housing. And due to the built in SIM card reader, the GM862 modules can support three SMS types: Mobile Terminated MT class 0-3 with signalling of new incoming SMS, SIM full, SMS read, Mobile Originated class 0-3 with writing, memorize in SIM and sending and Cell Broadcast compatible with CBDRX with signalling of new incoming SMS.

NOTE: the hot removal of the SIM sensing is not supported during power saving mode, and that is why we must continuously test the loading level on our GM862, so that we replace the battery before that the power saving mode takes place. Thereby, on the GM862 tracking sequence model, we will take care of the battery load level.

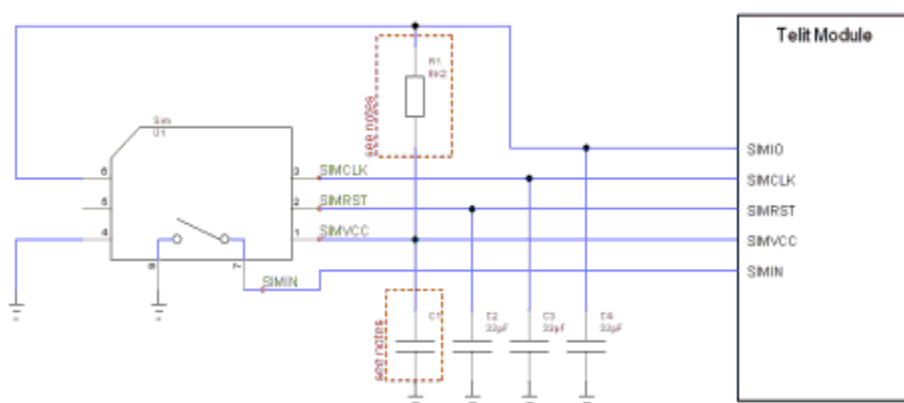

Fig. IV. iv: The SIM Card holder connection lines

In all the Telit modules, there are five pins for SIM Card holder connection: SIMVCC for SIM Power Supply, SIM RST for SIM Rest, SIMIO for SIM Data, SIMIN for SIM Presence and/or absence and SIMCLK for SIM Clock. That is why, the SIM connection design must take in account some general rules, such as:

- Data integrity, taking in consideration that SIMCLK has frequency of 3.57 MHz and SIMIO baud rate is greater or equal than 9600Bps
- EMI/EMC, taking in consideration the antenna picking-up digital noise coming from SIM card lines, the antenna radiated field that may interfere digital lines, and this later in particular clock which may radiate spurious in the surrounding space

4-Conclusion:

In this chapter, we have quoted with deep details, the composition of the GM862-GPS module, which, once added to the masterpiece that we care about, will allow us to track its geographical position. Then, in case of theft, we can geolocate it and bring it back to the museum, from which it was taken. In this way, our country's heritage will be perfectly preserved.

In the next chapter, we will talk about the different tools and technologies that we will use during our project, to design then develop and finally install the needed applications: the embedded system with Python code and the tracking application for the monitoring station.

Chapter V: Chosen Tools and Technologies

1- Introduction

Due to our project's bidirectional aspect, as it is related at the same time to the networking and the embedded systems, we will talk in this chapter about the window application that we will conceive, develop and then install on the monitoring terminal, and the python script that we will develop to add it in a later stage to the micro controller of the GM862 module.

This design chapter will be composed of two parts: an analysing section, which is related to the technologies we have chosen to undertake it and a technical section, which is related to the tools, either hardware or software ones, that we will use to accomplish our project.

2-Technologies Selection:

2.1- Unified Modelling Language

UML is a graphical modelling language which is based on pictograms. It appeared in the world of software engineering in the context of the "object-oriented design". This later is commonly used in software projects. It is now standardly defined by the Object Management Group (OMG) which is used to specify, visualize, modify, and build the useful documentation for the proper development of a software by providing standard modelling in order to represent the software architecture. The different representable components are: object or software activities, actors, process, database diagram...

This graphical modelling language will allow us to design our project, getting GM862 and the security agent as actors, the informations related to the artefacts, the actors, as a database, and the tracking and the geolocation as process....

2.2-Embedded Software:

Embedded software is computer software, written to control machines or devices that are not typically thought of as computers. It is typically specialized for the particular hardware that it runs on and has time and memory constraints. This term is sometimes used interchangeably with firmware, although firmware can also be applied to ROM-based code on a computer, on top of which the OS runs, whereas embedded software is typically the only software on the device in question.

We will use Python to develop our embedded software, also called as a script, to control the GM862 module and make it able to geolocate the stolen master piece.

2.3-Python:

Python is a general-purpose, high-level programming language whose design philosophy emphasizes code readability. Python's syntax allows programmers to express concepts in fewer lines of code.

It is intended to be a highly readable language. It is designed to have an uncluttered visual layout, frequently using English keywords where other languages use punctuation. Furthermore Python has a smaller

number of syntactic exceptions and more special cases than C or Pascal. Python scripts are text files stored in NVM inside the Telit GM862-GPS module.

There's a file system inside the module that allows to write and read files with different names on one single level (no subdirectories are supported). It is possible to run only one Python script at the time. This Python script is executed in a task inside the Telit module at the lowest priority, making sure this does not interfere with GSM/GPRS normal operations. This allows serial ports, protocol stack etc. to run independently from the Python script which interacts with the Telit module functionality through four build-in interfaces.

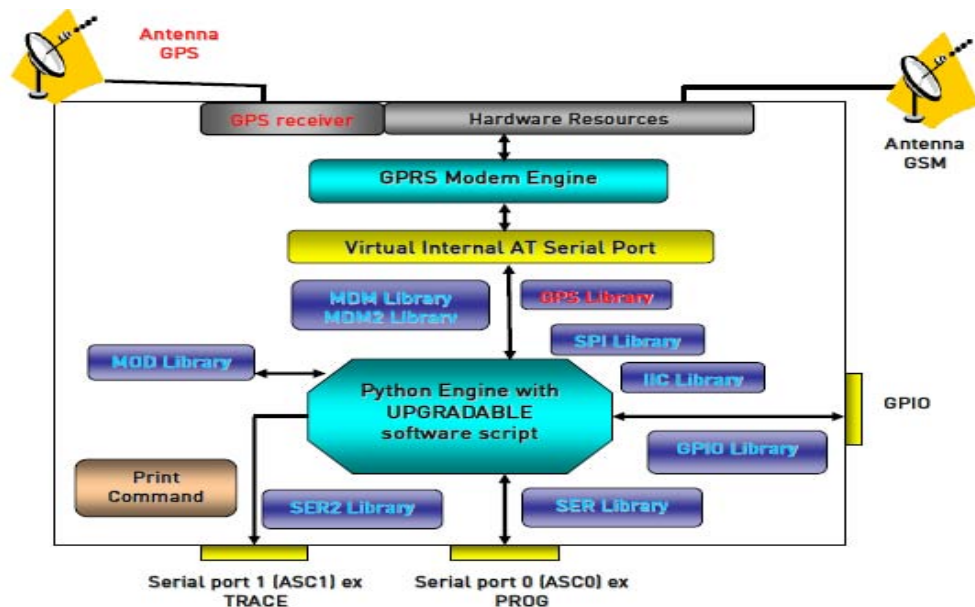

Fig. V. i: Python Script Interaction with the GM862-GPS functionalities

The **MDM** interface is the most important one. It allows Python script to send AT commands, receive responses and unsolicited indications, send data to the network and receive data from the network during connections. It is quite the same as the usual serial port interface in the Telit module. The difference is that this interface is not a real serial port but just an internal software bridge between Python and mobile internal AT command handling engine. All AT commands working in the Telit module are working in this software interface as well. Some of them have no meaning on this interface, such as those regarding serial port settings. The usual concept of flow control keeps its meaning over this interface, but it is managed internally.

The **MDM2** interface is the second interface between Python and mobile internal AT command handling. It is used to send AT commands from Python script to mobile and receive AT responses from mobile to Python script when the classic MDM built-in module already in use.

The **SER** interface allows Python script to read from and write to the real physical serial port ASC0, that is usually used to send the AT commands to the module, for example to read information from external device. When Python is running this serial port is free to be used by Python script because it is not used as AT command interface since the AT parser is mapped into the internal virtual serial port. Thereby, no flow control is available from Python on this port.

The **SER2** interface allows Python script to read from and write to the real physical serial port ASC1, which is usually available for trace and debug.

The **GPIO** interface allows Python script to handle general purpose input output faster than through AT commands, skipping the command parser and going directly to control the pins.

The **MOD** interface is a collection of useful functions.

The **IIC** interface is an implementation on the Python core of the IIC bus Master. It allows Python to create one or more IIC bus on the available GPIO pins.

The **SPI** interface is an implementation on the Python core of the SPI bus Master. It allows Python to create one or more SPI bus on the available GPIO pins.

The **GPS** interface is the interface between Python and mobile internal GPS controller. It is used in order to handle GPS controller without dedicated AT commands through MDM built-in module.

2.4-Easy GPRS:

The Easy GPRS feature provides a way to replace the need of an Internet TCP/IP stack at the terminal equipment side. The steps that will be required to obtain a virtual serial connection (that is actually a socket) to the Internet peer are: configuring the GPRS Access and the embedded TCP/IP stack behavior, defining the Internet Peer to be contacted, request the GPRS and socket connections to be opened (host is connected), exchange raw data and close the socket and GPRS context. All these steps are achieved through AT commands. As for common modem interface, two logical statuses are involved: in Command Mode (CM), some AT commands are provided to configure the Data Module Internet stack and to start up the data traffic and in data traffic mode (Socket Mode, SKTM), the client can send/receive a raw data stream which will be encapsulated in the previously configured TCP / IP packets which will be sent to the other side of the network and vice versa. Control plane of ongoing socket connection is deployed internally to the module

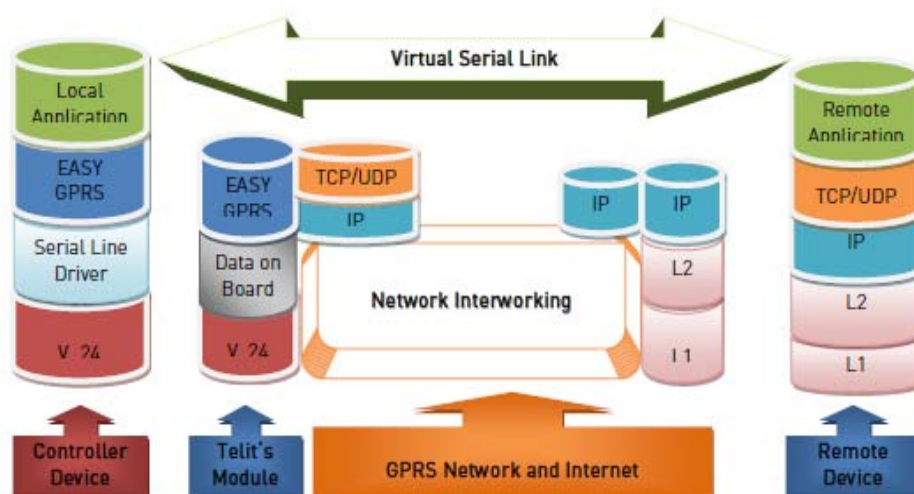

Fig. V. ii: AN example of the Protocol Stack Involved in the devices

2.5- Jammed Detect and Report Extension:

The Jammed Detect & Report feature allows a Telit GM862-GPS module to detect the presence of a disturbing device such as a Communication Jammer and give indication to the user and/or send a report of that to the network. This feature can be very important in alarm, security and safety applications that rely on the module for the communications. In these applications, the presence of a Jammer device can compromise the whole system reliability and functionality. Therefore it shall be recognized and reported either to the local system for Counter measure actions or to the network providing remote actions.

Our project's aimed scenario could be an intrusion detection system that uses the module for sending the alarm indication with an SMS to the security agent to inform him about the geographical coordinates of the stolen masterpiece, and the theft incomes using a Jammer. This aims to prevent any communication between the GSM module and the network. In such a case, the module detects the Jammer presence even before the break in and can trigger an alarm siren, or sending SMS to the monitoring station which will forward it to the security agent so that he calls the police

2.6- SIM Access Profile:

The SAP feature allows the module to use the SIM of a remote SIM Server. This feature is implemented using special AT Command on a Virtual circuit of the CMUX interface. The module sends request commands to the client application through a binary message that is crowned in the CMUX message. The client application shall extract the message and send it to the SAP server, through the appropriate protocols (e.g. by RFCOMM, that is the Bluetooth serial port emulation entity). The client application shall extract all the messages sent by SAP server and put them in the CMUX message, to be sent to the module.

The module satisfies the following feature requirements: Connection management, Transfer APDU, Transfer ATR, Power SIM on, Report Status and Error Handling.

2.7- Easy Script Extension - Python interpreter:

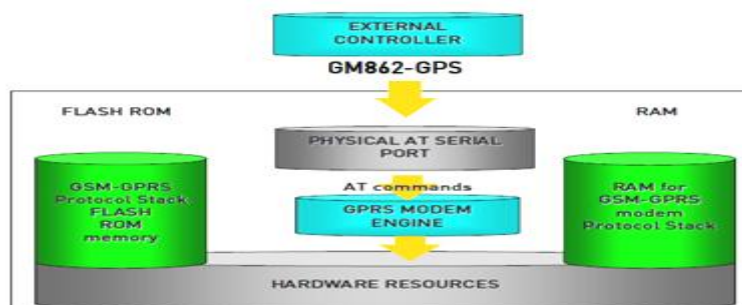

The Easy Script Extension is a feature that allows driving the modem "internally", writing the controlling application directly in a nice high level language: Python. The Easy Script Extension aims at low complexity applications where the application was usually done by a small microcontroller that managed some I/O pins and the GM862-GPS through the AT command interface.

In order to eliminate this external controller, and further simplify the programming of the sequence of

Fig. V. iii: Structure of Managing Some I/O pins and GM862-GPS through the AT Command interface

operations, inside the GM862-QUAD-PY / GM862-GPS it is included:

- Python script interpreter engine v. 1.5.2
- +Around 3MB of Non Volatile Memory room for the user scripts and data
- 1.2 MB RAM reserved for Python engine usage

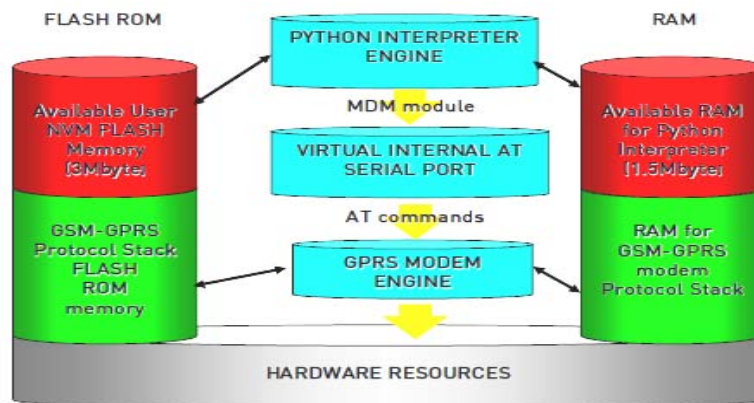

Fig. V. iv: Our requirements Schematic Approaches

g- AT commands:

The GM862 module can be driven via the serial interface using the standard AT commands. The GM862 module is compliant with:

1. Hayes standard AT command set, in order to maintain the compatibility with existing SW programs.
2. ETSI GSM 07.07 specific AT command and GPRS specific commands.
3. ETSI GSM 07.05 specific AT commands for SMS (Short Message Service) and CBS (Cell Broadcast Service)
4. FAX Class 1 compatible commands

Moreover the GM862 supports also Telit proprietary AT commands for special purposes.

2.8- VB .net :

Visual Basic .NET (pronounced VB dot net) is a Microsoft object-oriented programming (OOP) language. It evolved from Visual Basic 6 (VB6) to meet an increasing need for easy web-services and web development. VB.Net was designed to take advantage of the .NET framework-based classes and run-time environment. It was re-engineered by Microsoft as part of its .NET product group. VB.NET supports abstraction, inheritance, and polymorphism...

The most substantial VB6 to VB.NET modification is OOP, which allows for class and object creation and increased code reusability. Many new controls were added to streamline program development. VB.NET also supports multithreading and Web development such as Web forms and services. Its data handling is represented and exchanged via XML-based ADO.NET, which allows efficient and easy handling of large amounts of data via the Web.

2.9- MVC software architecture:

In addition to the embedded system that we will implement on GM862, our second aim is to design and implement a geo-antitheft application that would be set up on the monitoring station. This application will be an MVC based platform,

We have chosen the MVC model to accomplish our application through My SQL database as a Model, My SQL VB.Net and MYSQL Net connectors as Controllers and Visual Studio 2010 IDE user Interfaces as a View.

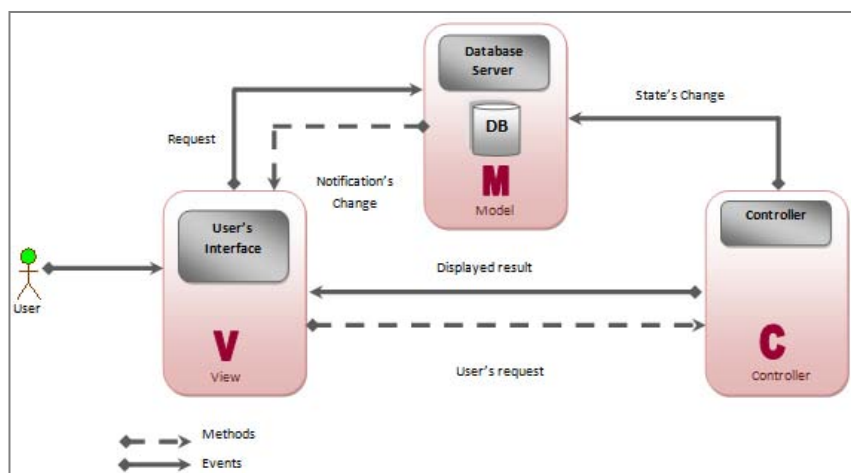

Fig. V. v: Our Project's Architecture-MVC

Model-view-controller (MVC) is a software architecture pattern which separates the representation of information from the user's interaction with it. The model consists of application data, business rules, logic, and functions. A view can be any output representation of data, such as a chart or a diagram. Multiple views of the same data are possible, such as a bar chart for management and a tabular view for accountants. The controller mediates input, converting it to commands for the model or view. The central ideas behind MVC are code reusability and separation of concerns.

2.10- Open Database Connectivity:

In computing, ODBC (Open Database Connectivity) is a standard C programming language middleware API for accessing database management systems (DBMS). The designers of ODBC aimed to make it independent of database systems and operating systems; an application written using ODBC can be ported to other platforms, both on the client and server side, with few changes to the data access code.

ODBC accomplishes DBMS independence by using an ODBC driver as a translation layer between the application and the DBMS. The application uses ODBC functions through an ODBC driver manager with which it is linked, and the driver passes the query to the DBMS. An ODBC driver can be thought of as analogous to a printer or other driver, providing a standard set of functions for the application to use, and implementing DBMS-specific functionality. An application that can use ODBC is referred to as "ODBC-compliant"

2.11-V_Model life cycle:

The V-model represents a software development process (also applicable to hardware development) which may be considered as an extension to the waterfall model. Instead of moving down in a linear way, the process steps are bent upwards after the coding phase, to form the typical V shape. The V-Model demonstrates the relationships between each phase of the development life cycle and its associated phase of testing. The horizontal and vertical axes represent respectively time or project completeness (left-to-right) and level of abstraction (coarsest-grain abstraction uppermost).

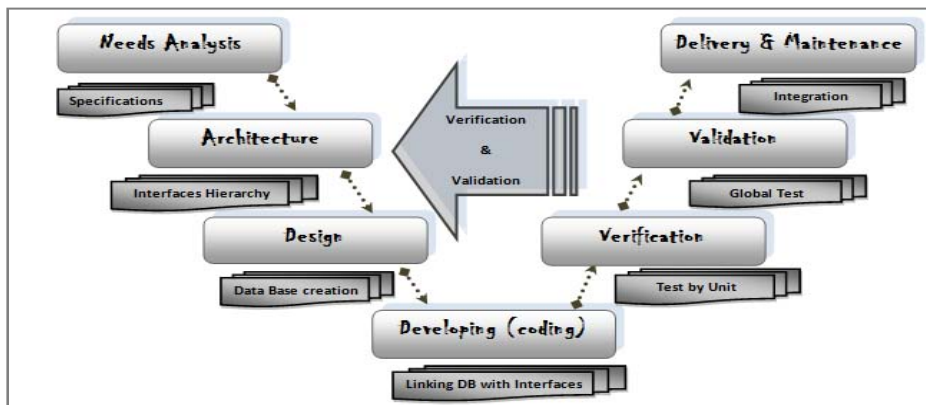

The V-Model provides guidance for the planning and realization of projects. The following objectives

Fig. V. vi: V-Model Life Cycle

are intended to be achieved by a project execution: minimization of Project Risks, improvement and Guarantee of Quality, reduction of Total Cost over the Entire Project and System Life Cycle and improvement of Communication between all Stakeholders.

3- Conclusion:

In this chapter, we have mentioned with details, the different tools and technologies that we have used to develop our geo-antitheft application. In the next chapter, we will start our designing part, which we have done through StarUML tool.

Chapter VI: Our Geo-Antitheft Application Design

1-Introduction :

The main objective of this chapter is to organize and understand the application and model the problem in an object-oriented way. Indeed, the analysis model describes the use cases and makes an initial allocation of system behaviour between the various objects.

In this design phase, we will define the purpose(s) of the geo-antitheft program, we will make a quick functional program analysis, to essentially determine the data that will be processed (input data), the method (also called algorithm) and the result (output). The input and output can be very diverse in nature. We can describe the method used to accomplish the goal of a program using an algorithm. Procedural and functional programming is based on algorithms. We generally find the same basic functionalities.

2-Designing Tool Selection:

StarUML:



We started our project by analysing our aim: becoming able to geolocate any stolen artefact through the use of GM862 module. During the design phase, and being dependent of our project's specifications, we have used StarUML to conceive our application. It made us able to treat class diagrams uses cases, sequences diagrams... StarUML is a software modelling platform that supports UML (Unified Modelling Language). It is based on UML version 1.4 and provides eleven different types of diagram, and it accepts UML 2.0 notation. It actively supports the MDA (Model Driven Architecture) process by supporting the UML profile concept. StarUML™ excels in customizability to the user's environment and has a high extensibility in its functionality.

3-Use-Cases Diagrams:

During this stage of our master thesis, we will study the different statements of our application, by designing its different use cases, through which we will specify the end-user needs and the behaviour of the application that we are currently designing and implementing.

Generally these diagrams are only synoptic, aiming to describe the behaviour of the concerned system, the geo-antitheft application in our case.

3.1-Actors presentation:

For an architected UML application, we speak no longer about users. In this application, players are simply named: actors. Before designing the use-cases diagrams, we must start with the accuracy of these players in our geo-antitheft application. To do this, we will define the three main actors of our application together with their tasks as follows:

Agent:

- Artefacts database management: In this part, a security agent can access to the artefacts database just for checking an artefact, modifying an already registered one, adding a new one, or deleting a previous one.

- **Artefact types:** In this part, a security agent can access to the artefacts types database just for checking an artefact type, modifying an already registered one, adding a new one, a deleting a previous one.
- **GM862 database management:** In this part, a security agent can access to the GM862 database just for checking a module, modifying an already registered one, adding a new one, or deleting.

Administrator:

In addition to the yet mentioned use-case, we can add to the administrator type of accounts, the privilege of managing agents' accounts, privileges list.

- **Accounts database management:** In this part, the administrator can access to the accounts database just for checking an account, modifying an already registered one, adding a new one, or deleting

3.2- Use-cases design:

In the computer system, and to run an application between the client and the server, we need an intermediary: it is a host, which ensures good man-machine communication. Thus, when developing an application, it is essential to take into account the satisfaction of the end user from the standpoint of reliability and ease of handling. We must therefore conceive the use cases and deduce the different use-cases diagrams that we will encounter. The purpose of these charts is to have a global vision on the future of software interfaces. These diagrams are composed of actors who will act in use-cases.

a- Geolocation Use-Case:

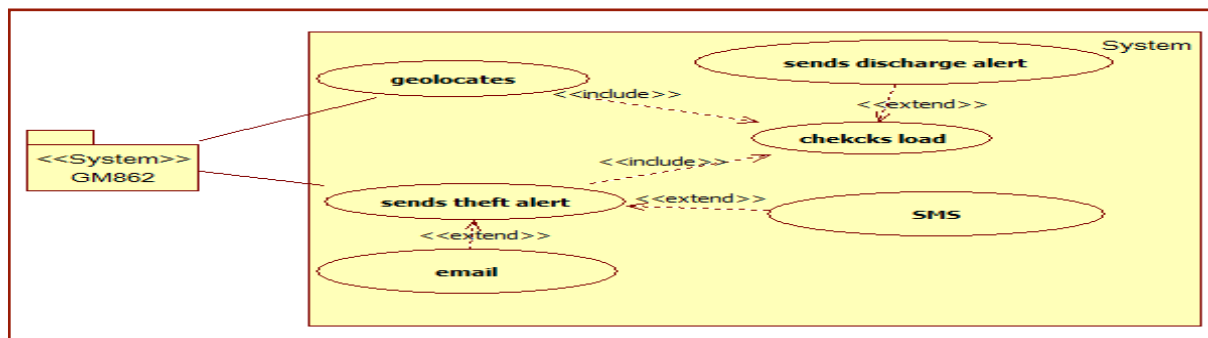

Fig. VI. i: Geolocation Use-Case

Geolocation: In this use-case, our actor is not human; it is an external automatic system. First of all, GM862-GPS module should keep the load so that we guarantee that it is still working once the Artefact is outside the museum. And to avoid the uselessness if the load is down, we will program an alert message, which will make GM862 measure its load and compare it to an exact alert value. If this latter is reached, GM862 should alert the security agent to change it. Besides, GM862 should geolocate its geographic coordinates, and send a theft alert once it is stolen.

b- Authentication Use-Case:

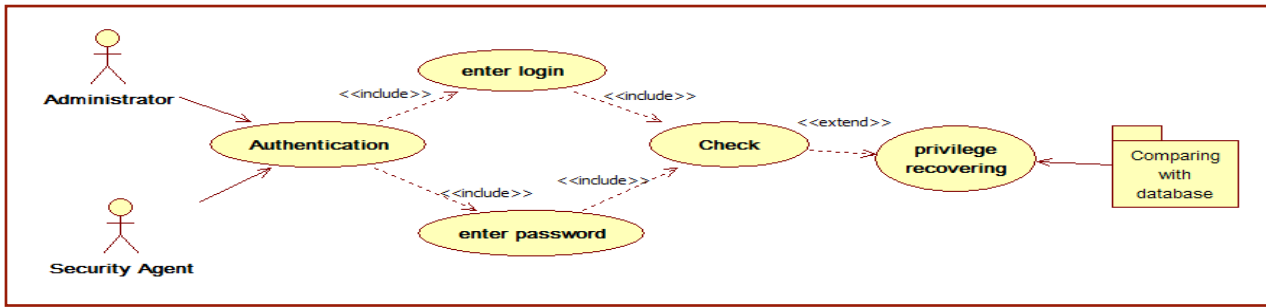

Fig. VI. ii: authentication use-case

Login: This use case represents the required authentication procedure to connect and access to the geo-antitheft application, whether the user is an administrator or a security agent. Each user of this application: (administrator or agent) has a user name and a password to connect through the authentication interface of the application. After an extraction of data from the database, the system decides to grant the user’s access to the interface which is related to his own privilege, or to show him a fault input error message.

c- Administrator use-case:

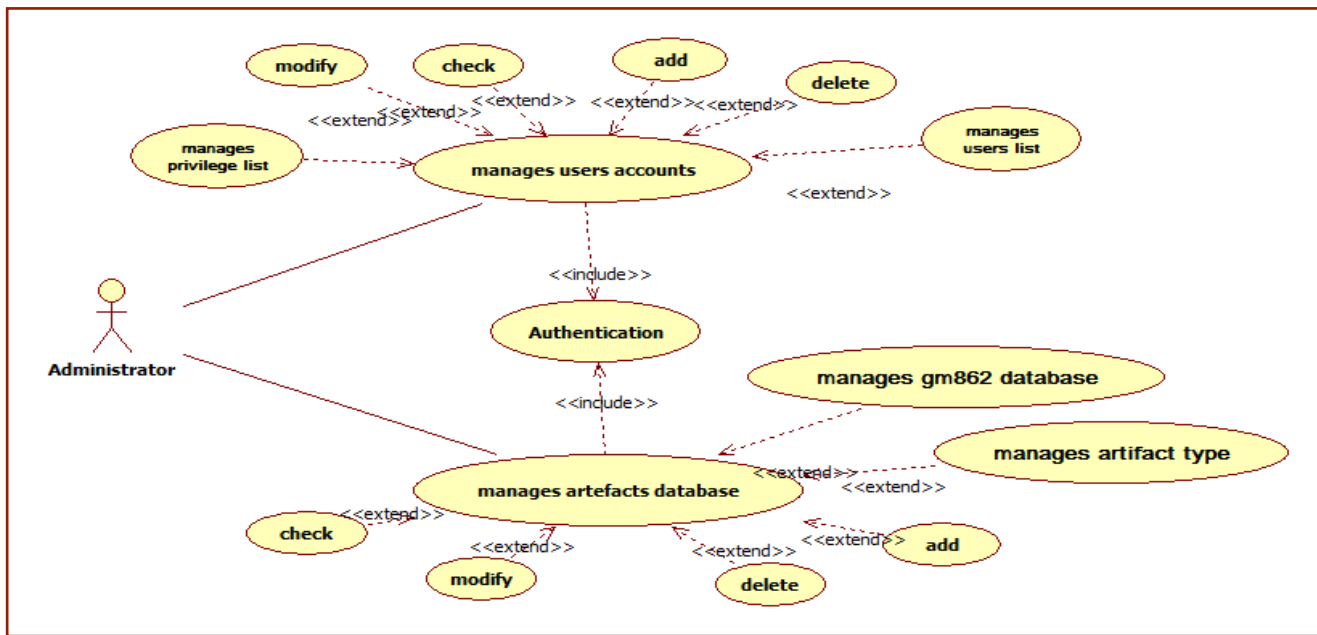

Fig. VI. iii: Administrator use-case

Managing: The administrator’s use-case covers managing users’ accounts and artefacts at the same time. Besides, managing artefacts database is extended with managing their types and their related GM862 modules, keeping in mind that all these use-cases include authentication.

d- Security Agents use-case:

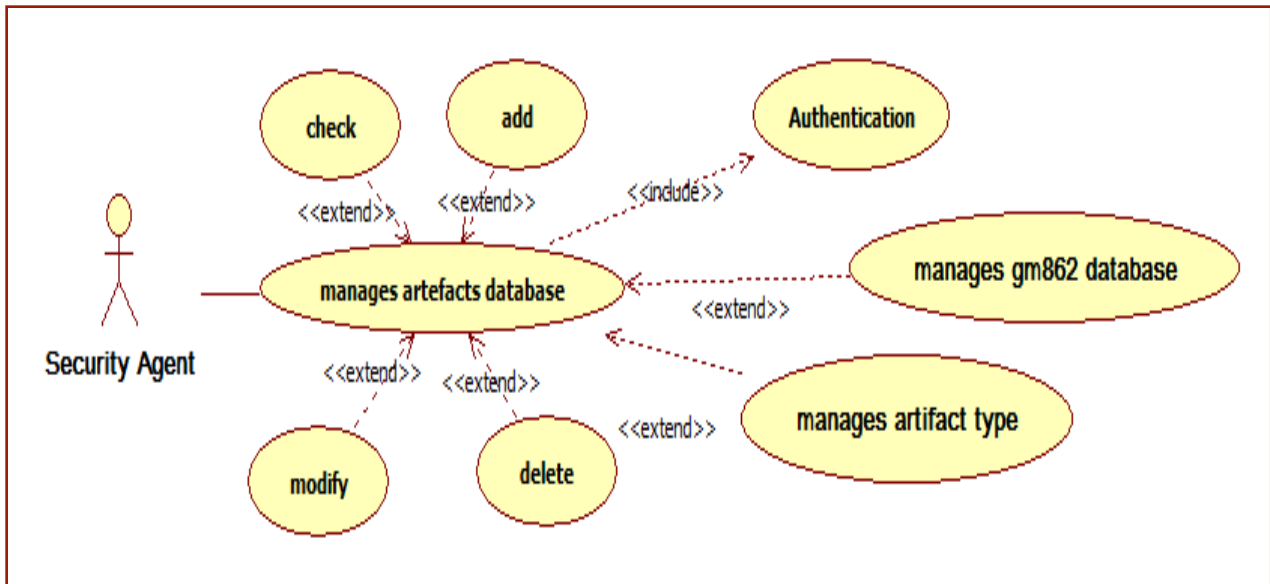

Fig. VI. iv: Security agent use-case

Security Agent: Once authenticated, the security agent will only find his own tasks attainable, such as managing artefacts and geolocating database, because all the tasks that are related to the administrator’s privilege will be disabled.

4- Activity Diagrams:

In the Unified Modelling Language, activity diagrams are being used to describe the step-by-step workflows of the system’s tasks and components. An activity diagram shows the overall flow of control. In this part, we will set the different activity diagrams of our geo-antitheft system, by mentioning every action state and decisions.

4.1-Checking load AD:

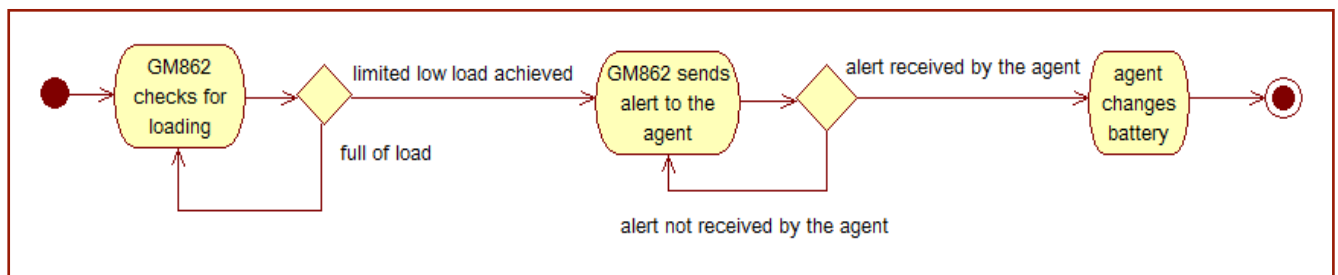

Fig. VI. v: Checking for Load Activity Diagram

Script: While developing Python code for the GM862 module, we should take into account to specification of a fixed time interval for load testing, and an accurate load value, which, once reached, GM862 must send an alert to the agent to change it.

4.2- Geolocating ACTIVITY DIAGRAM:

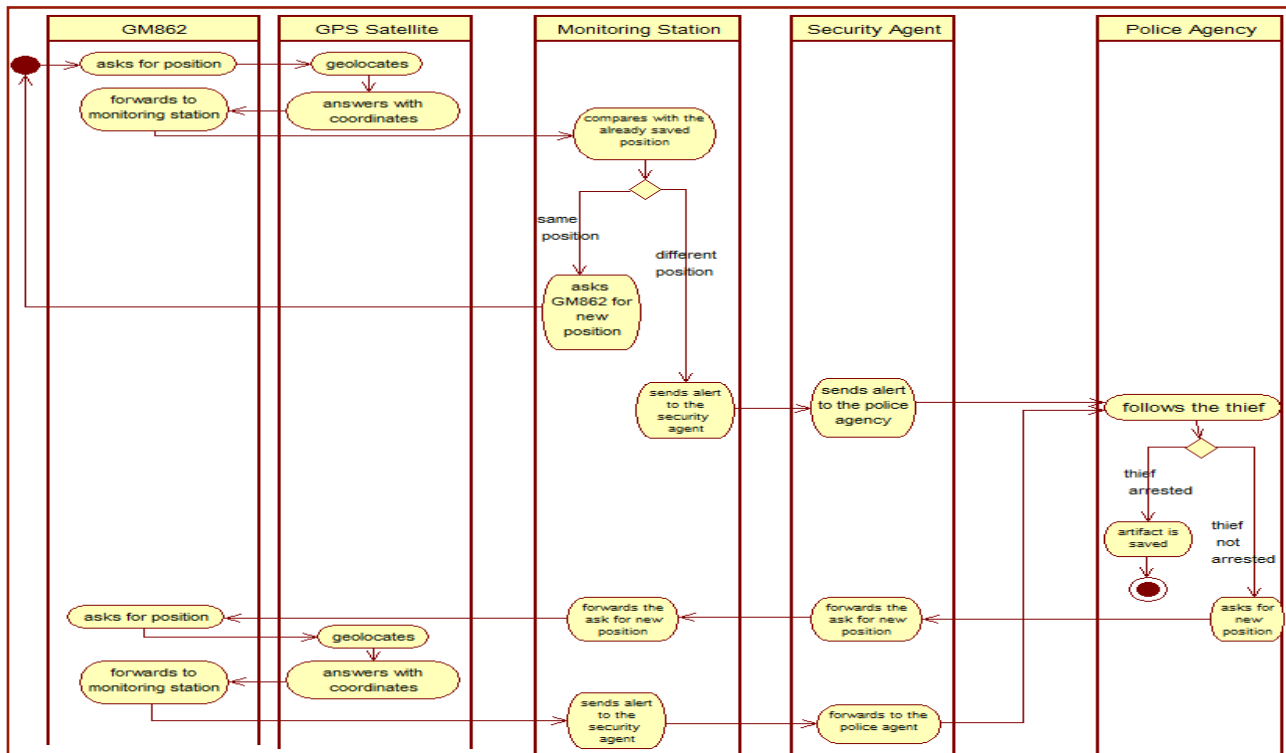

Fig. VI. vi: Geo-Antitheft Activity Diagram

Script: The whole geo-antitheft scenario gathers five actors who are so dependent on one another, that we can never describe each actor's role individually. The police agency, can never send their agent to follow the stolen artefact, unless the security agent calls them. And the latter can never warn the police agency, unless he receives geographic coordinates that do not match with the original ones. Besides, the GM862 module can never send the geographic coordinates unless it tracks the stolen artefact via satellite. That is why, our geo-antitheft script, groups all the actors at the same time.

5- Sequence Diagrams:

A sequence diagram is a kind of interaction diagram that shows how processes operate with one another and in any order. It is a construct of a Message Sequence Chart. A sequence diagram shows object interactions arranged in time sequence. Like in the last activity diagram that we have analysed, the sequence diagram is also dependant on all the actors.

GM862 should continuously practise a comparative study between its yet registered geographic coordinates and the last detected ones. As if different, it should capture the new position through satellite and send the new coordinates to the monitoring station. The latter will warn the Security agent, who will call the police and ask them to follow the thief in order to arrest him and bring back the stolen artefact. In this way, the temple of any country's priceless heritage will be saved.

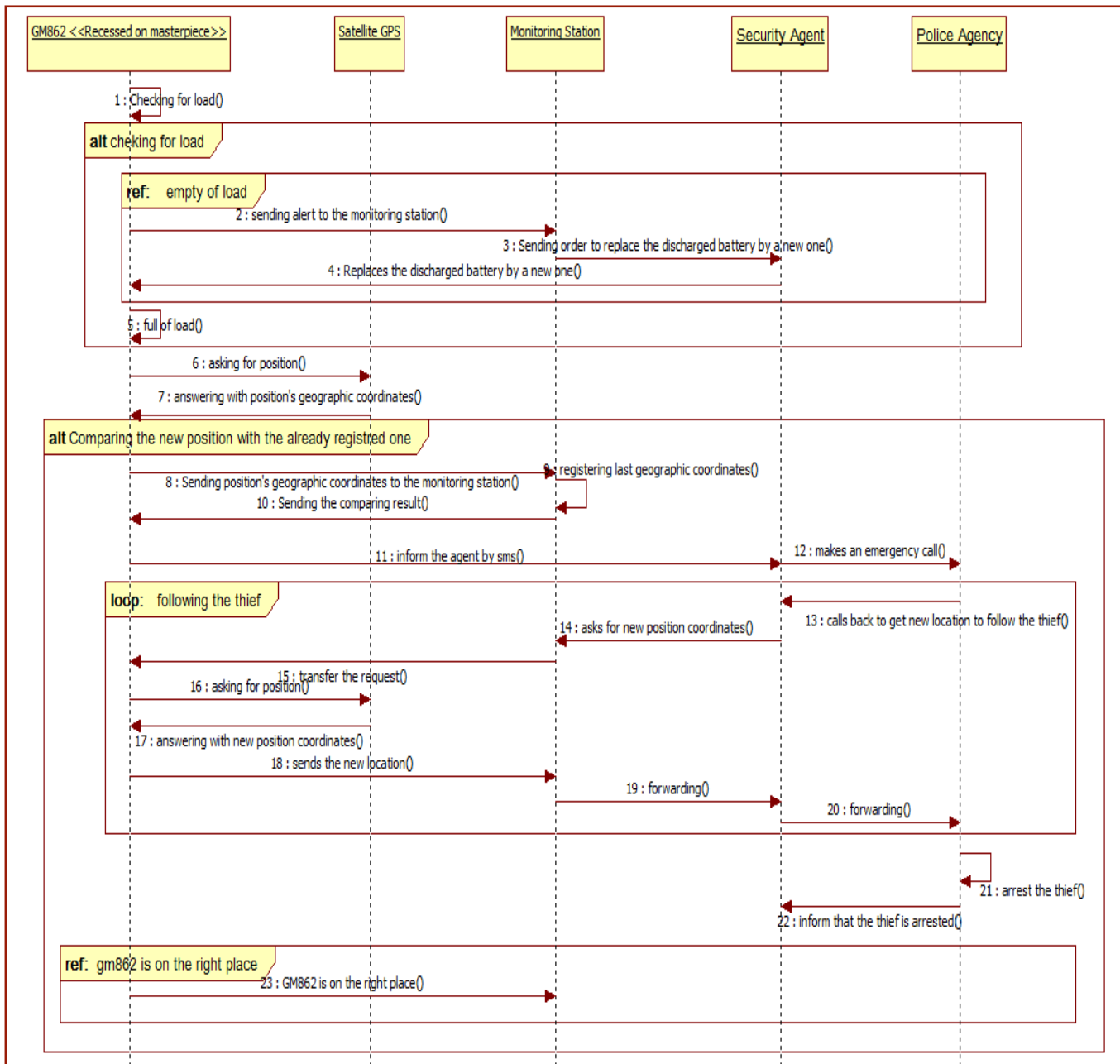

Fig. VI. vii: Geo-Antitheft Sequence diagram

6- Class Diagram:

In software engineering, a class diagram in the Unified Modelling Language (UML) is a type of static structure diagram that describes the structure of a system by showing the system's classes, their attributes, operations (or methods), and the relationships among the classes. The class diagram is the main building block of object oriented modelling. It is used both for general conceptual modelling of the systematics of the application, and for detailed modelling translating the models into programming code. Class diagrams can also be used for data modelling. The classes in a class diagram represent both the main objects, interactions in the application and the classes to be programmed. Through the next table, we will describe our class diagram model, its entities, and the associations between them.

Class	Properties
Artefact	A class that contains the artefact attributes, such as its name, reference and receipt date
Artefacts types	Artefacts type attributes concern the sort, to which it belongs, such as mosaic, sculpture, painting...
GM862	A class that contain each GM862 attributes such as serial number, geographic coordinates...
Alert	An alert class is characterised by date, time and alert message as attributes
Users	A user class contains as attributes his input identity informations such as name, birthday, email...
Accounts	An account class is created by an administrator, adding as attributes: login and password...
privileges	A privilege class concerns the account sort, to which a user account belongs

Table 2: Classes Definition

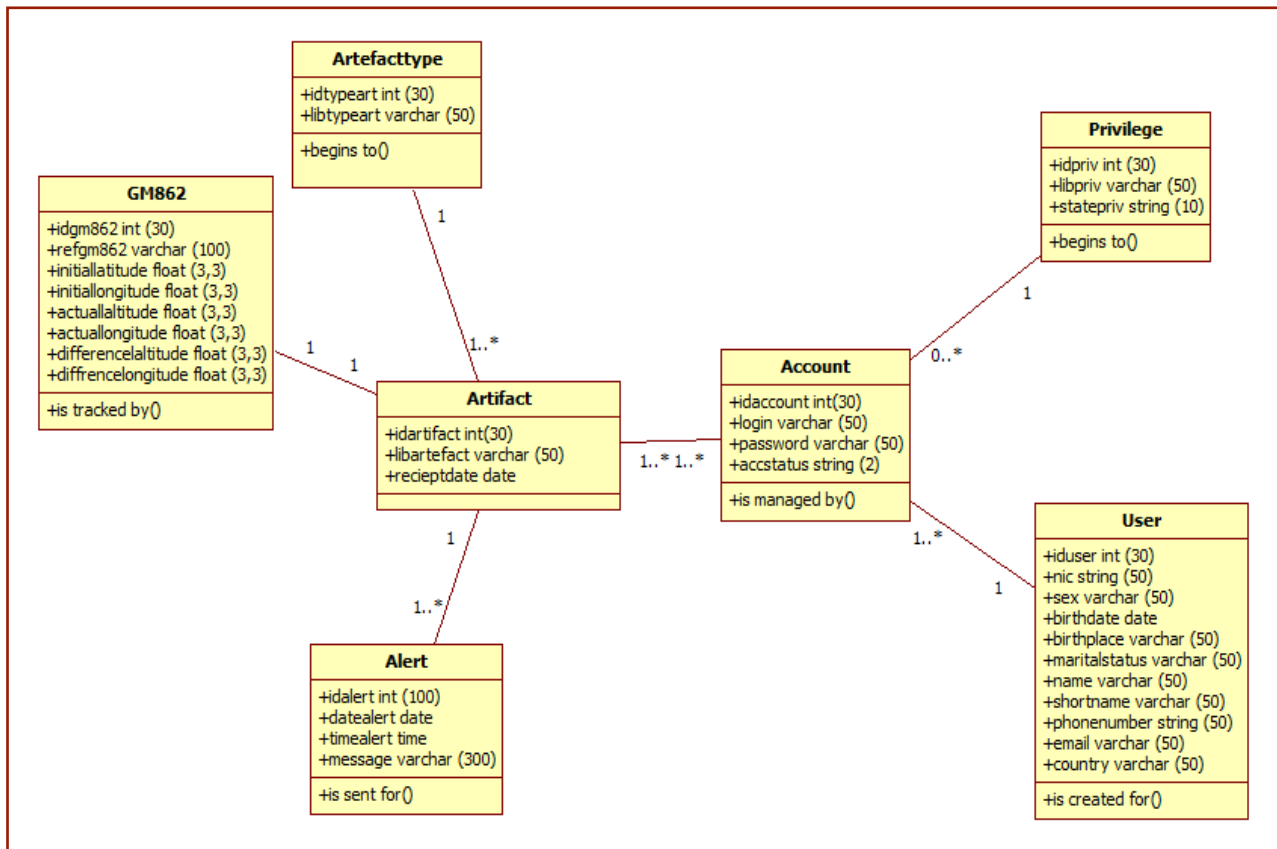

Fig. VI. viii: Class Diagram

7- Relational model (classes/attributes):

GM862 (idgm862, refgm862, initiallatitude, initiallongitude, actuallatitude, actuallongitude, differencelatitude, differencelongitude, #idartefact)

Artefact (idartefact, libartefact, recieptdate, #idtypeart, #idgm862, #idalert, #idaccount)

Artefacttype (idtypeart, libtypeart, #idartefact)

User (iduser, nic, sex, birthdate, birthplace, maritalstatus, name, shortname, phonenumber, email, country, #idaccount)

Privilege (idpriv, libpriv, statepriv, #idaccount)

Account (idaccount, login, password, acstatus, #idpriv, #iduser)

8-Geo-Antitheft Application Model:

We have chosen the progressing frame since it adapts to the needs of most users. The objective is to maintain a balanced hierarchy that allows quick access and an intuitive understanding of how the pages are organized.

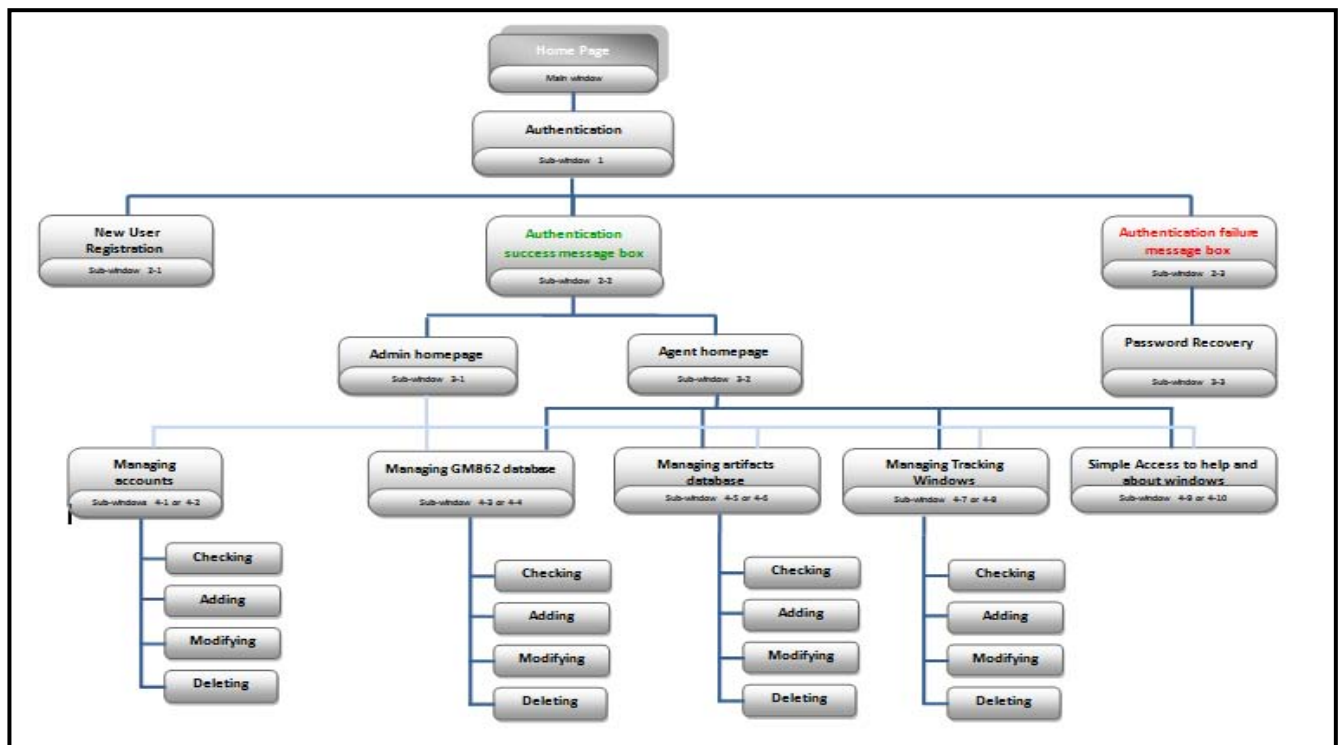

Fig. VI. ix: Geo-Antitheft Application Model

9- Graphic Design:

The purpose of the graphic design is to maintain graphical consistency in our project's interfaces design. To achieve this goal, we used the MDI model: Multiple Document Interface which refers to the organization of an application's graphical interfaces, where "parent" windows contain within them child windows. The typical case of application is in the main application window, with a menu and toolbars containing a sub-file or window open project.

9.1-Main Window's standardised Graphic charter:

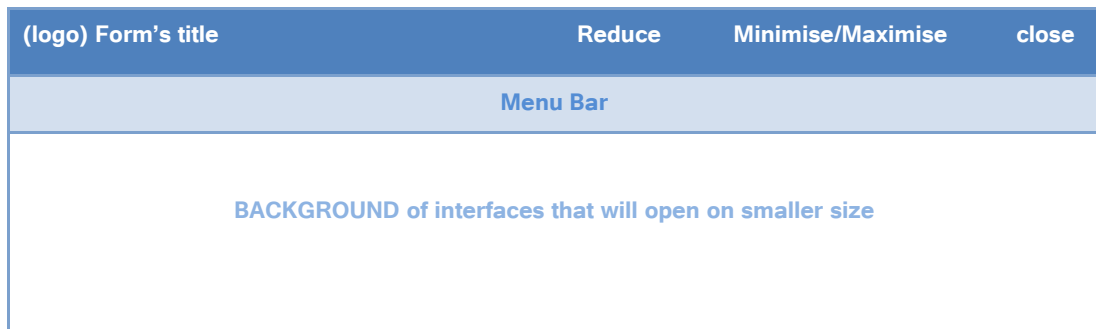

Table 2: main window design

Part 1: Header of the main interface of our application, common to all our project's charters. It contains the name of the interface (which we left as form1 only for the general interface), close, minimize and reduce buttons, automatically generated while creating the form, and which can be removed just by changing the properties of their Window style between true and false, depending on what we want to appear in the interface.

Part 2: Menu Bar, composed of different links that once clicked, will make us able to open the various windows of the application. It is created with the tool: MenuStrip that leads to a menu bar, which can extend at each level by a submenu.

Part3: Middle of the main window, on which will appear the different sub-windows of our application.

9.2- Sub windows standardized Graphic charter:

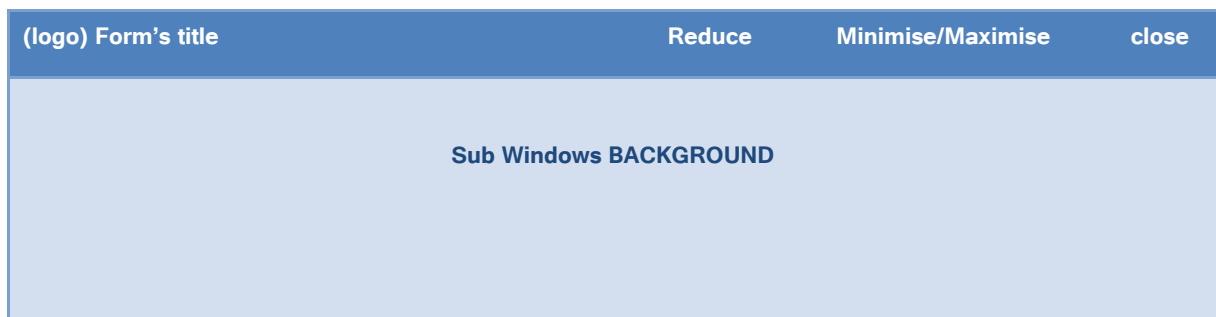

Table 3: Sub Windows Design

10- Conclusion:

This chapter has been devoted to modelling the static aspect of our system, which is based on the detailed specifications that we have mentioned in the previous chapters. In the next chapter we will process the implementation part.

Chapter VII: Development

1-Work Environment:

In this part, we will focus first on the hardware tools, to mention the different equipments we have used, either for tracking such as the GM862-GPS module, its GPS and GSM antennas and its battery, or for development such as our host, by mentioning its criteria. Then we will enumerate the software tools that we have used for developing, either for the python script, or for the main interfaces of the window application.

1.1-Hardware tools:

a- GM862-GPS module:

The GM862-GPS module is specifically designed and developed by Telit for OEM usage and dedicated to portable data, voice and telemetric applications, such as: Telemetry and Telecontrol, Security systems, Vending Machines, POS terminals, Phones and Payphones, Return channel for digital broadcasting, Applications, where the external application processor can be replaced by the PYTHON engine provided by GM862-GPS, Automotive and Fleet Management applications and Position reporting and tracking.

b -Evaluation Kit:



Fig. VII. i: RS232/USB Evaluation Boards - EVK3

In order to assist us in the development of our geolocating module based application, Telit (GM862 provider) supplies us an Evaluation Kit that interfaces the Telit GM862-GPS module, directly with appropriate power supply, SIM card housing, RS 232 serial port level translator and USB, direct UART connection, antenna and all General Purpose I/O ports of Telit GM862 Family modules supported in a dedicated connector. The EVK provides a fully functional solution for a complete data/phone application. The standard serial RS232 9 pin connector placed on the Evaluation Kit allows the connection of the EVK system with a PC or other DTE.

c- GPS Antenna:

The Telit GM862-GPS Transceiver module includes a 50 Ohm MMCX connector for the GPS antenna, which is characterised by GPS L1 (1575.42 MHz) as a Frequency range and ± 1.023 MHz as a band width.

d- GSM Antenna:

The antenna that the customer chooses to use, should fulfil the following requirements: a Frequency range provided by the network operator and a bandwidth which can be either 80 MHz in EGSM 900, or 70 MHz if GSM 850, or 170 MHz in DCS, or even 140 MHz PCS band.

e- Battery:

The total power consumption of GM862-GPS is the sum of the consumptions of GSM and GPS parts. Habitually, Telit provides with GM862-GPS its own battery loader which is suited for 3.7V Li-Ion rechargeable battery (suggested capacity 500-1000mAh). The Charger needs only a CURRENT LIMITED power source input and charges the battery directly through VBATT connector pins..

e- Host:

Our Host is needed for conceiving, developing and generating python code for the embedded system, and the windows application that will ensure the geographic position database up to date with any modification that GM862-GPS will support. We will use a Dell Inspiron N5010 laptop, equipped with an **I3** microprocessor, a 4 gigabytes of RAM, and Windows 7 (64) as an operating system.

1.2- Software Tools :

a- Python IDLE:

 python™ IDLE is Python's Tinker-based Integrated Development Environment, which emphasizes a lightweight, clean design with a simple user interface. Although it is suitable for beginners, even advanced users will find that IDLE has everything they really need to develop pure Python code. We have used Python IDLE to develop the python tracking code that we will later integrate as a script on the GM862-GPS module via Rsterm.

b- Rsterm:

 rsterm Rsterm is an easy to use serial terminal software, built to speed up development or activities dedicated to GSM/GPS/GPRS operations and Telit extended features: special efforts were made to support Telit modems with their custom functionalities. Rsterm is software involving GSM modems, using standardized and custom AT commands. Special serial port handling controls are provided, while Rsterm can be used with any generic GSM modem. We have used it to configure the connection between the EVK motherboard and the Gm862-GPS Module, in order to upload the python code from the host to the module.

c- Visual Studio 2010 ultimate:

 Microsoft Visual Studio is an integrated development environment (IDE) from Microsoft. We have used it to develop the console and the graphical user interfaces of our geo-antitheft application, which is characterised with Windows Forms , to be installed after that on the monitoring station.

Visual Studio includes a code editor supporting IntelliSense as well as code refactoring. The integrated debugger works both as a source-level debugger and a machine-level debugger. Other built-in tools include a forms designer for building GUI applications, web designer, class designer, and database schema designer.

d- PHP my admin:



We have managed our database through Phpmysql, which is a free and open source tool written in PHP intended to handle the administration of MySQL with the use of a web browser. It can perform various tasks such as creating, modifying or deleting databases, tables, fields or rows; executing SQL statements; or managing users and permissions.

e- SQL connector:



MySQL Connector/ODBC (sometimes called just Connector/ODBC or MyODBC) is a driver for connecting to a MySQL database server through the Open Database Connectivity (ODBC) application program interface (API), which is the standard means of connecting to any database. We have used it to connect the application that we have developed with the data base that we can manage through our application.

2- Python Script for GM862-GPS:

In this part, we will mention some steps by which we have passed in order to develop the python code that we will alter on a script to finally integrate it in the GM862-GPS module.

2.1- Connecting GM862-GPS module to the Evaluation Kit EVK:

While the gm862 module can be very lucrative for the embedded system, development can be embedded because of tight footprint tolerances and variable voltage requirements. The module interfaces to a 50 pin Molex connector, requires 3.8V @ 2A peak to operate, and communicates at 3.3V serial TTL. These interface specifications must be overcome just to be able to 'talk' to the device.

After having developed and saved the python code, we should upload it to the GM862-GPS module, by connecting it to the EVK toolkit, using the RS232 connector on the EVK serial port and its related USB cable on the host. Once connected after having pressed the start button on the EVK, and while we run the Rstern, we choose the Com port and we click on Open button, which will make this message box appear, asking us to confirm the serial port selection to connect the GM862, once confirmed, another message box will appear to confirm that the connection is well established.

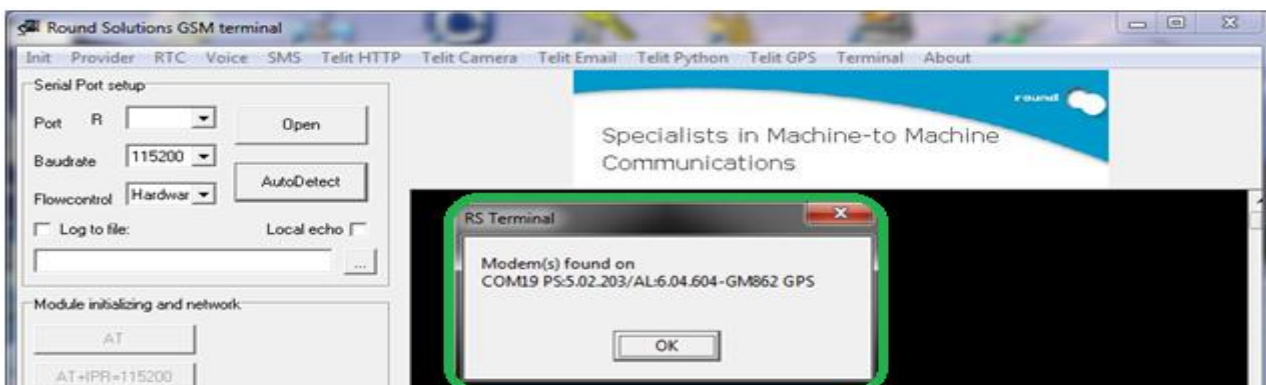

Fig. VII. ii: RS232 Serial Port connection of EVK

The sim card should have been inserted on the sim card reader of the GM862-GPS module before alimentering it, and once connected to the com port; we should establish the connection to the sim card.

Then we will execute the AT commands, in order to initialize the module and the network. And once connected to GM862 module, the masterpiece should be localised on its initial position that we will later compare with new positions tracked in a theft case, due to which, SMS about geographical coordinates of the stolen masterpiece will be sent regularly.

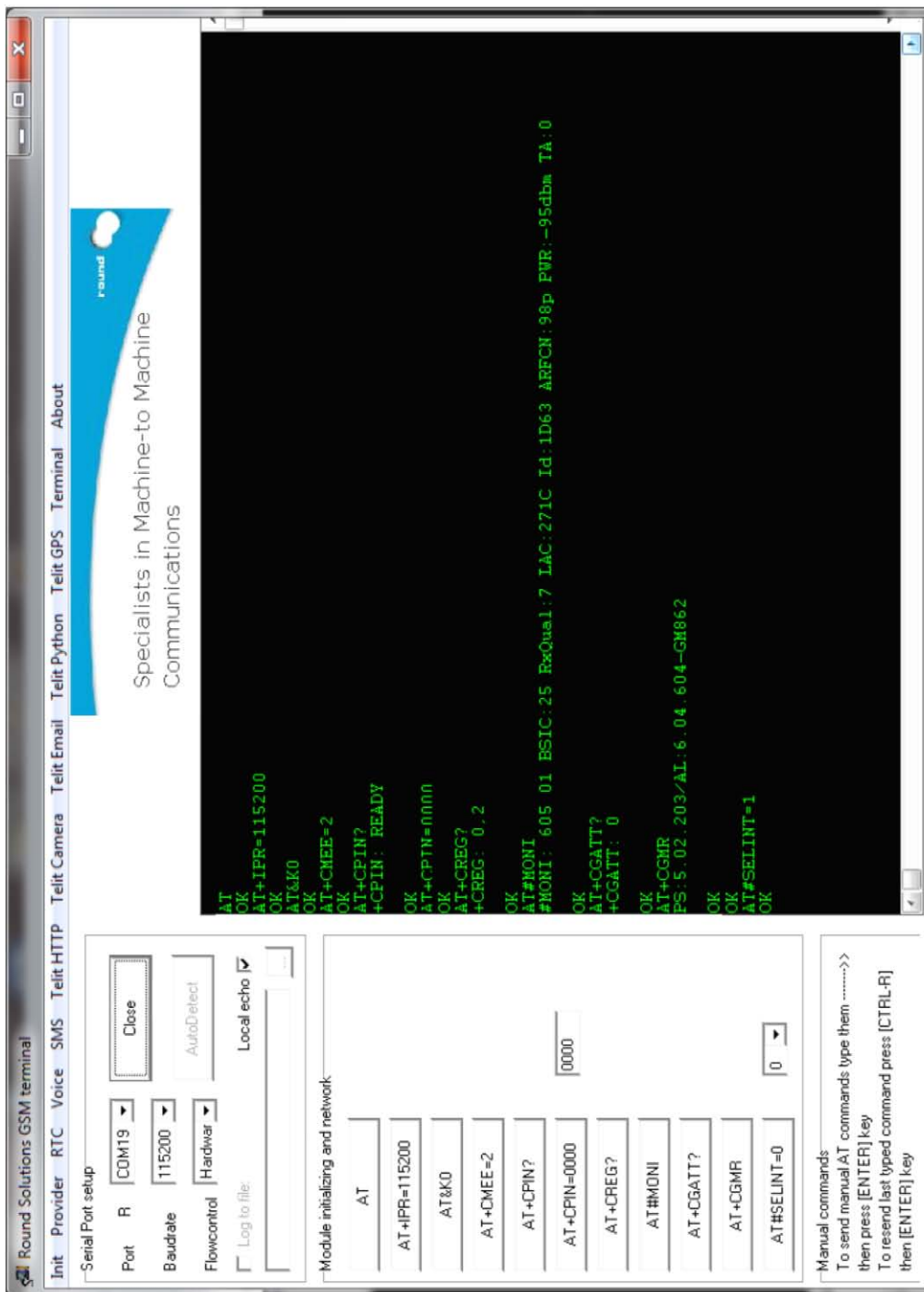

Fig. VII. iii: Sim Card connection via AT commands

2.3- Python Code importation:

Once connected, we should upload the yet written python code on the GM862-GPS module, by clicking on the Telit Python heading, then import the python code and finally click on the button: "upload selected file from the PC to the Module" to import the script to the GM862-GPS module, followed by the compile of the selected file from code to script which will be used as an embedded system on the GM862-GPS.

And now, as we have uploaded the embedded system on GM862-GPS, we should create the Window application through the vb.net programming language, and its related database on MySQL, having installed easy PHP as a database server, and its derivative Phpmysql as a database management application.

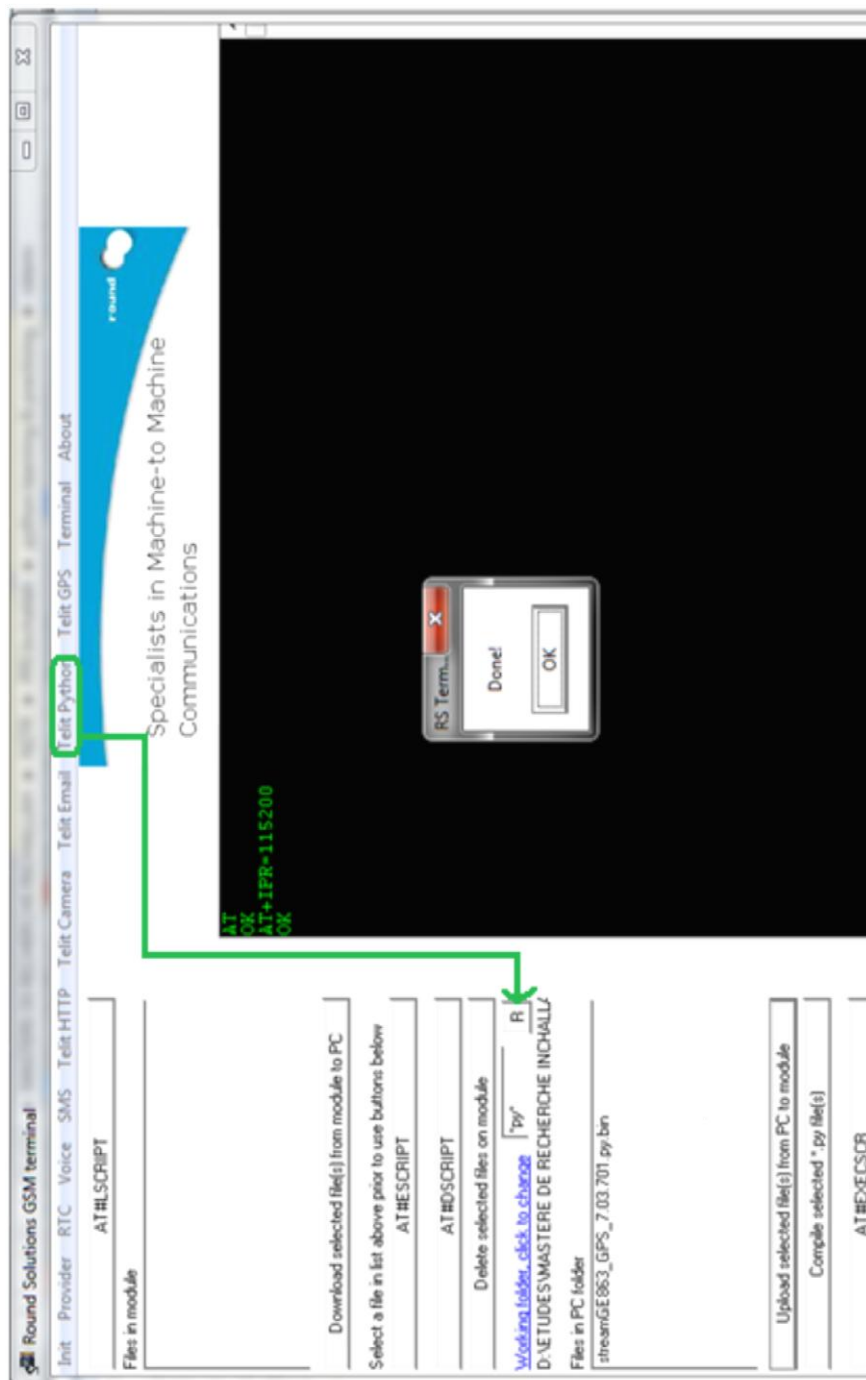

Fig. VII. iv: Python Script Importation to the module GM862-GPS

3-Database creation and connection:

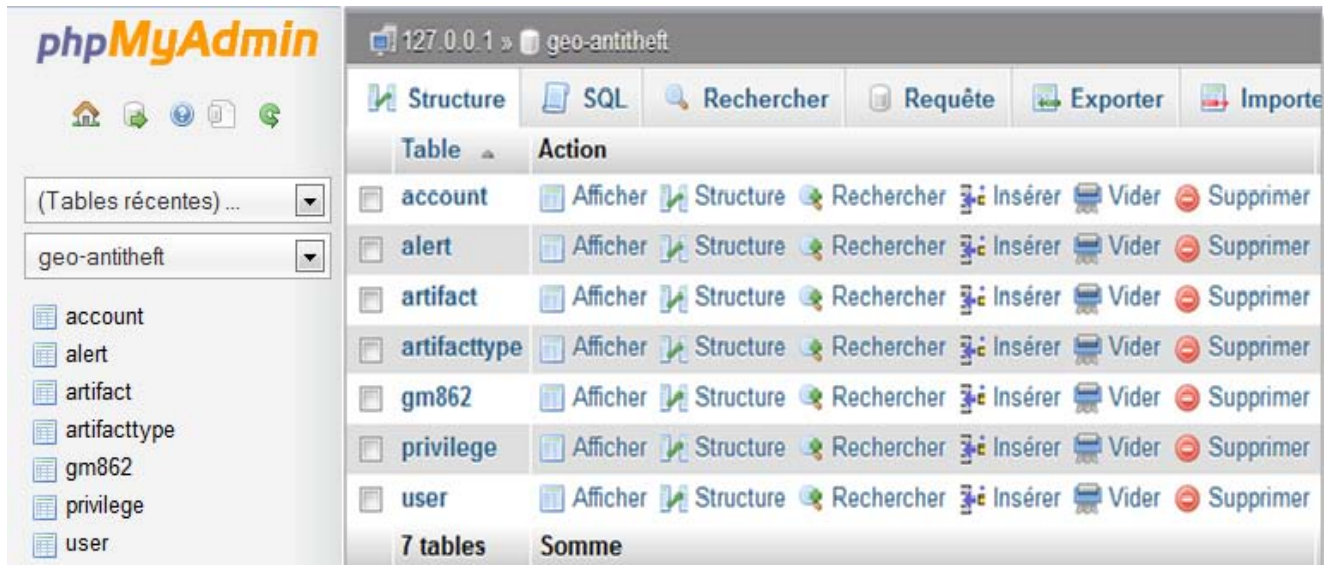

Fig. VII. v: Database Creation on PHP my Admin Tool

Having installed the dot net / mySql_connector and the DBMS MySQL, we have created a database and baptized it with Geo-Antitheft as a name. Then we have created the tables that we have already mentioned on the design chapter. After that, we have connected our work environment to the database via the SQL connector. Subsequently, we will be able to directly manage the database through our interfaces.

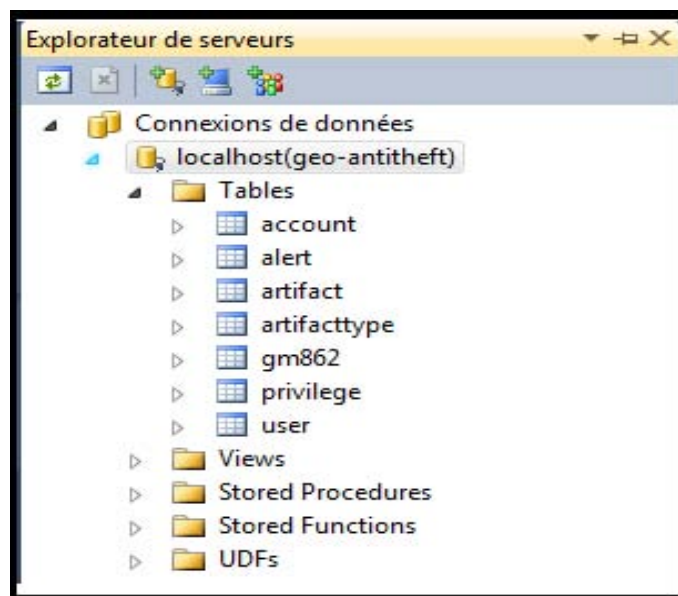

Fig. VII. vi: Geo-Antitheft Database Connection

4- The tracking windows application on the Museum Local Host:

In addition to the python script that we have uploaded on the GM862 module, we have conceived then developed a tracking application that we will present in this part, by explaining the aim of each window.

4.1-Authentication and its related sub-Windows:

The authentication Sub-window represents a start-up window, which automatically appears on the top-most of the PPP main window, letting this later disabled. The PPP main window will become enabled only after the authentication success, which is confirmed after a comparison between the input data and the database one.



Fig. VII. vii: Authentication Sub-Window

If the user still has no account, he can create a new one through the “create a new account” link, so that the administrator assigns him a login and a password. And if the agent has forgotten his password, an error message will appear (Fig.VII.vi), asking him to try again or to contact the administrator



Fig. VII. viii: Error Message



Fig. VII. ix: Password Recovery

By clicking on the forgotten password link, the security agent can recover his password by filling the password recovery sub-window (Fig. VII.vii), and once he clicks on the recover button, an automatic password recovery link will be sent to his e-mail, allowing the security agent to renew his password. But once renewed, he can't use it unless the administrator approves it for him.

4.2- Start-up Window:

Perfectly Protected Pearls main window's design is characterized by the blue to white trend, with a picture of the earth, surrounded by GPS satellites, in order to point to the geolocation process. We have added to this main window, a menu bar, which drop down menus are displayed, providing us access to the different sub-windows.

The same start-up window is seen either by a security agent or by the administrator, but the access right to the accounts sub-menu is only reserved to the administrator, and if the agent logs in, he will find that sub-menu disabled.



Fig. VII. x: Start-up Main Window

4.3-Users Sub-Windows:

This window can be used in two different cases: either by a new user asking for a new account creation or by the administrator if he checks users' details to create or update their account. This sub-window is reachable by the user through the new account creation link on the authentication sub-window, and by the administrator through the menu bar by choosing the Edit Users menu's drop down.

Fig. IV. v: Users' Sub-window, used by users

Fig. IV. vi: Users' sub-window, used by the administrator

4.4-Users' List Sub-window:

NIC	Gender	Date of Birth	Place of Birth	Marital Status	Name	Short Name	Phone Number	E-Mail	Country	Secret_Question	Secret_Answer	Address
2356982	Female	19/10/1975	Tataouine	Married	Hafsa Abbassi	Abbassi	2147483047	h.abbassi@gmail.com	Tunisia	where are you from?	Tataouine	Majd Street, Wardaya C...
98756231	Male	12/11/1982	Mater	Single	Ben Alm...	Rafik	2147483647	rafik.ba@topnet.tn	Tunisia	Your birthday?	12-11-1982	Tunisia
2569896	Male	23/05/1980	Mogren	Married	Bedis	Nehal	2147483647	n.bedis@hotmail.com	Alana	You mother's name?	Banja	Tunisia

Fig. VII. xi: Users' List Sub-Window

This sub-window is reachable only by the administrator, so that he can find the whole users database table with all its details, and from this sub-window, the administrator can only delete or check, as updating is possible only through the users' sub-window.

4.5-Accounts Sub-Window:

Find by:
 NameUser
 Login
 Privilege

User Surname: Privilege:

Login: Password:

Secret Question: Secret Answer:

E-mail: Account's State:

Fig. VII. xii: Accounts sub-window

Through this sub-window, the administrator creates new accounts for the security agents by assigning them a login and a password. Security agents can modify later the password but must wait for the administrator's validation.

4.6-Accounts' List Sub-window:

ID Account	Login	Password	Privilege	Account Status	Secret Question	Secret Answer	e-mail	Name
* 1	Faten	fpswd	Administrator	active	mother's name	Essia	feten_r@yahoo.fr	RIDENE
* 2	Ahmedba	bapswd	Security Agent	active	name of wife	malika	abanor@gmail.com	BEN AMOR
*								
*								
*								
*								
*								

Fig. VII. xiii: Accounts list sub-window

This sub-window is reachable only by the administrator, so that he can find the whole accounts database table with all its details, and from this sub-window, the administrator can only delete or check Accounts, as updating is possible only through the Accounts' sub-window.

4.7-Masterpiece's sub-window:

Fig. VII. xiv: Artefacts Managing Sub-Window

This sub-window is reachable, either by a simple security agent or by the administrator, in order to manage the Museum's masterpieces' database, by adding new articles, or updating yet existing ones. Every update should be inevitably done with the security agent's account indication, to be used later as a reference is one masterpiece is lost.

4.8-Artefacts list Sub-Window:

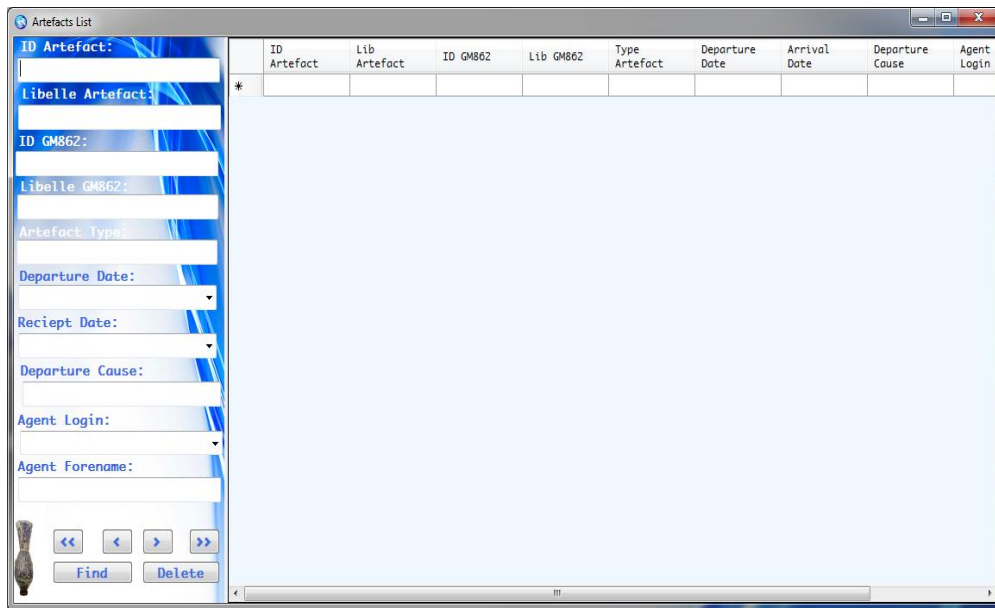

Fig. VII. xv: Artefacts List Sub-Window

This sub-window is reachable either by the security agent or by the administrator, so that they can find the whole masterpieces' database table with all their details, and from this sub-window, they can only delete or check artefacts, as updating is possible only through the Masterpieces' sub-window.

4.9-GM862-GPS Sub-Window:

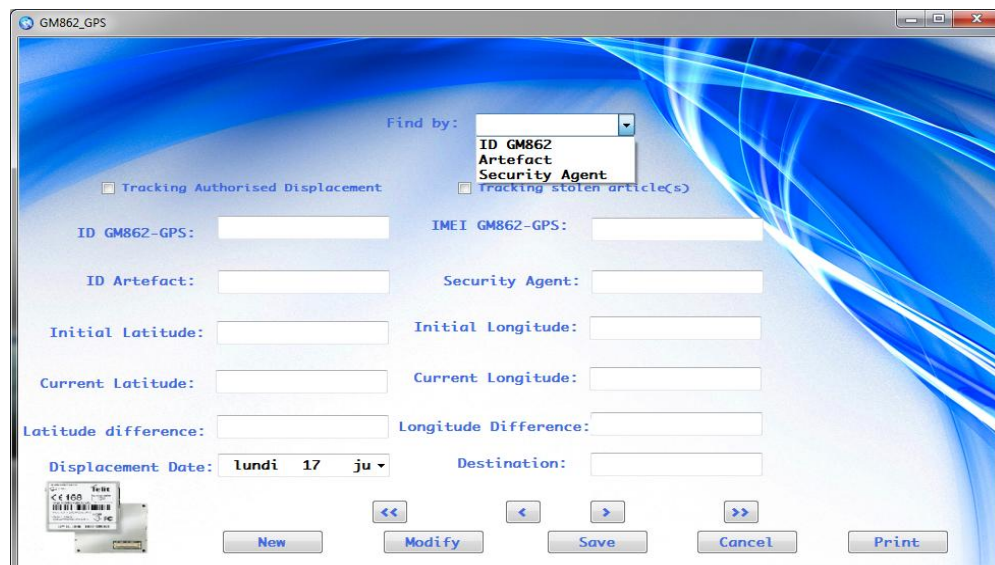

Fig. VII. xvi: GM862-GPS Sub-Window

Every time that the security agent adds a new artefact to the database, he should inevitably add its related GM862 module so that he ensures the article security through its tracking. Thereby the security agent should save the first geographic coordinates which are related to the masterpiece's position on the museum, to be able to compare it later to new tracked position, then deduce the artefact's displacement if the position is different from the yet registered one.

4.10- GM862-GPS list Sub-Window:

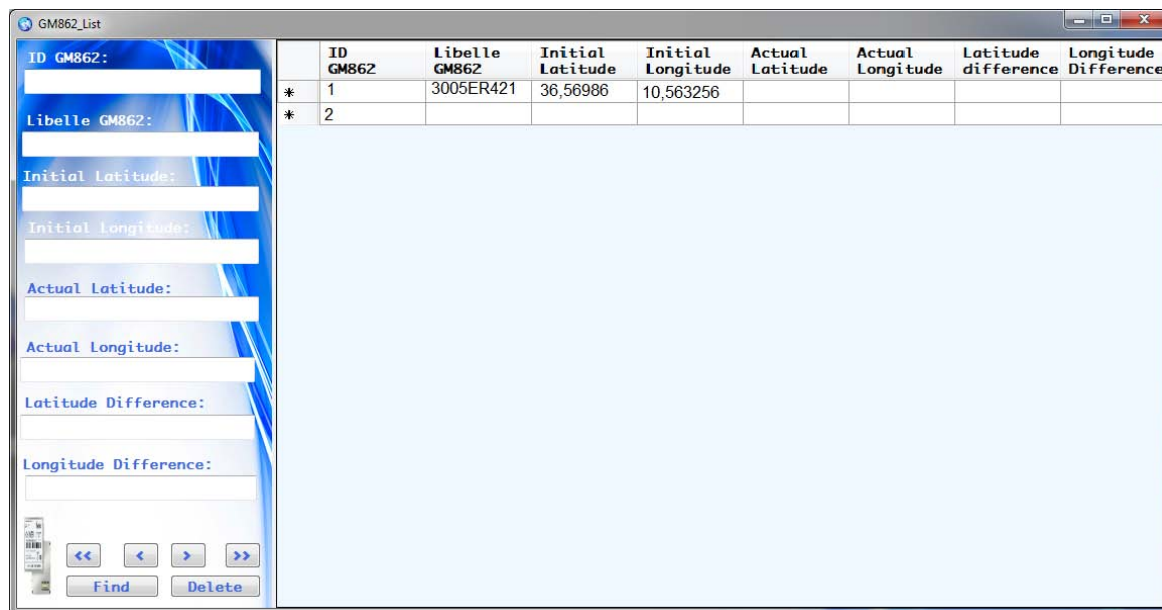

Fig. VII. xvii: GM862-GPS List Sub-Window

This sub-window is reachable either by the security agent or by the administrator, so that they can find the whole smart-tracking modules' database table with all their details, and from this sub-window, they can only delete or check GM862-GPS, as updating is possible only through the GM862-GPS' sub-window.

4.11- Tracking Theft Sub-Window:

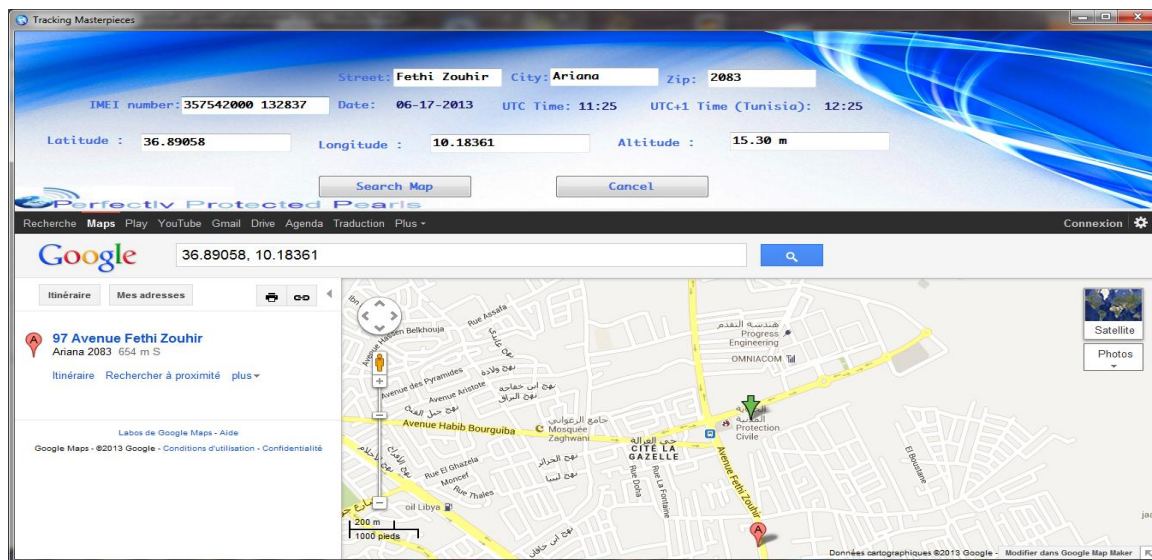

Fig. VII. xviii: Tracking Theft Sub-Window

Through this sub-window, the security agent can track the geographical position of the artefact, after having received the geographical coordinates of the masterpiece from the GM862 module, either during theft or authorized displacement. It gives informations about street, city, zip code, GM862 ID, date and time (UTC & UTC+1), latitude, longitude and altitude. This is how the security agent can inform the police agent about the position of the masterpiece.

4.12- Tracking History Sub-Window:

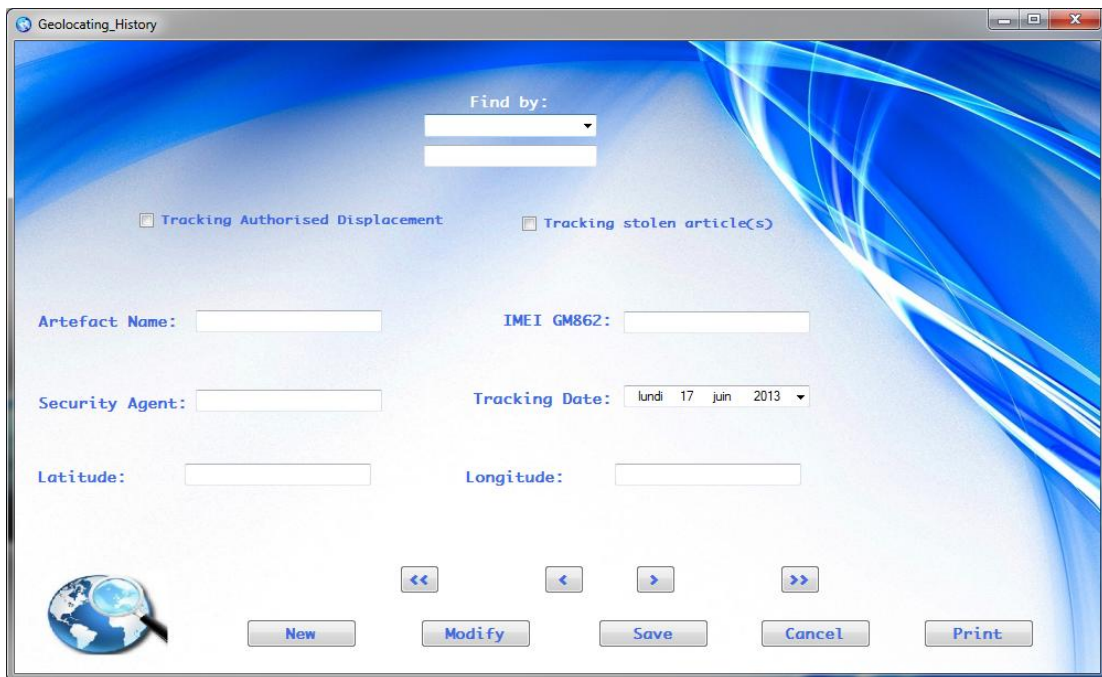

Fig. VII. xix: Tracking History Sub-Window

By this window, the security agent can look for or insert the history of the theft tracking or the authorised displacement tracking. The button modify is activated only while inserting a new tracking history, but if he is looking for a yet saved event, he is not allowed to modify it.

4.13-Help Sub-Window:

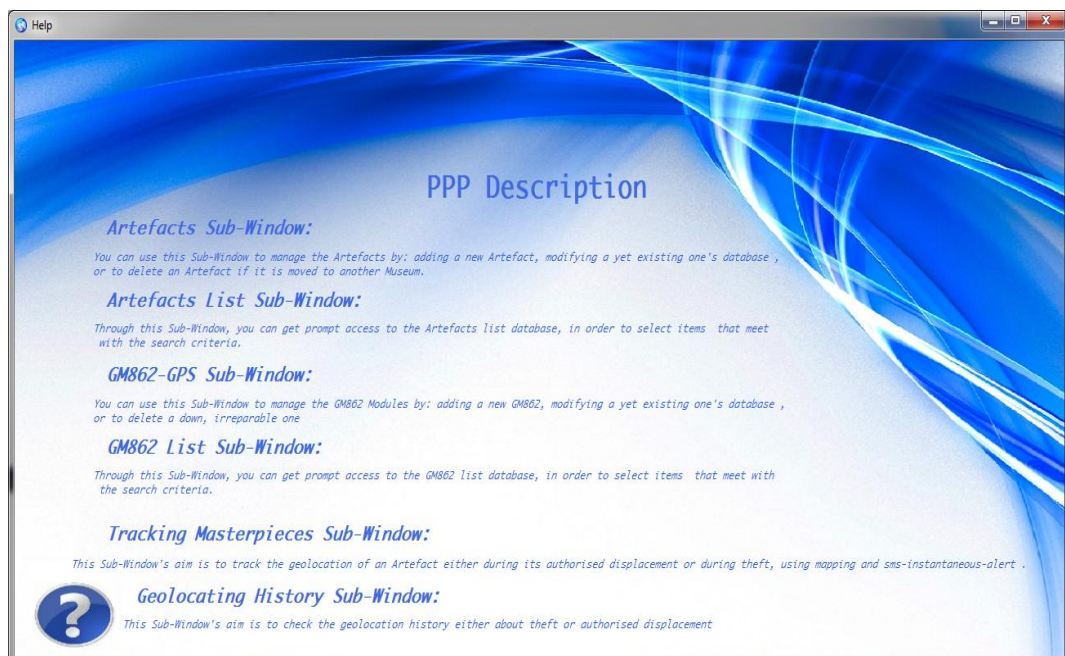

Fig. VII. xx: Help Sub-Window

Through this sub-window, the security agent can find an instruction manual which explains him each sub-window aim and how to use it with details. It is reachable from the question mark icon of the main window menu bar.

4.14- About Sub-Window:

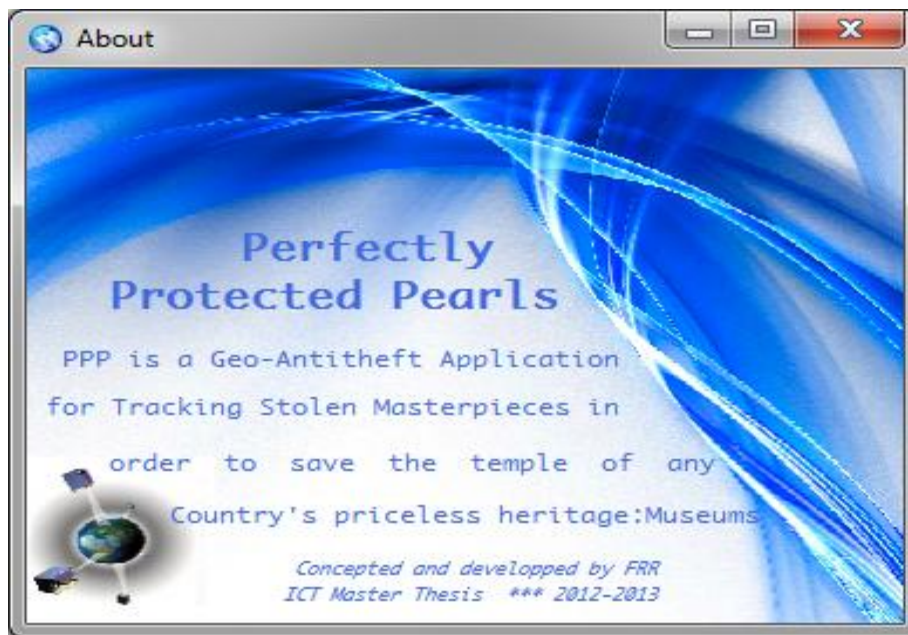

Fig. VII. xxi: The About Sub-Window

In this sub-window, we give a brief summary about our Geo-Antitheft Application that we baptised with the name: Perfectly Protected Pearls. It is reachable from the about link on the question mark sub-menu.

5-Conclusion:

In this chapter, we have focused on the hardware and the software tools that we have used in order to develop the python script for tracking via GPS Satellite and the windows form application which will be used by the security agent for tracking stolen masterpieces, and then we have listed the different print screens of our Perfectly Protected Pearls application, by explaining the functionality of each sub-window.

Chapter VIII

Conclusion

1-Conclusion:

The Geographical Information Systems possess various application areas and are often very difficult for a non-expert end user. That is why we have studied through our project the importance of how to provide a good security mechanism against theft which is faced by the museums. We had to think about an issue, such as GPS tracking, which fits with the existing network architecture, taking into account the sustainability, the evolution and reliability of this solution quite well as technical economic terms. For this, we thought of setting up a Smart prototype for tracking stolen antiques in order to save our exhibited history on national museums.

And due to the Gantt Diagram that we have made since the beginning of our master thesis, we have found that all our final project tasks were on track and have been well finished before the deadline.

On the beginning of our project, we had to deeply look for the GPS mechanism, ask for help and of course make attempts to understand this security machinery.

To prove our ability, we have constantly considered the fact of accomplishing already made topics, as an application and not a project. So it took us think of some innovation: protect immobile items by mobile security.

We encountered several difficulties to master this application, but having done deep research and hard work during four months, gave us the opportunity to fully develop our knowledge and skills in the smart security field.

Having accomplished all this project's steps positively, we can confirm that our graduation project have been very useful, as it allowed us to learn the embedded systems and the various performed tasks like design and development of a smart geo-antitheft application

2-Perspectives:

Starting by museums as first target audience, due to the priceless pearls that they exhibit in order to save the temple of any country's heritage, we can later use smart geo-antitheft modules to protect any immobile article against theft by tracking its geographical position, which will make the thieves arrest faster, and the stolen article retrieval quicker.

3-Recommendations:

As the Methodology used in this project is the prototyping, we recommend the following:

For further researchers to continue to create similar product for different museums to improve the security.

For museums, we recommend them to provide the financial requirements for smart geo-antitheft security modules in order to save the temple of any country's priceless heritage

4-References

1. Literature:

- [1.1] Museum, Vol XVII, n° 4, 1964, Andre F. Noble court (Paris, 31. VIII. 19639)
- [1.2] Mr. Fredrik Åsberg, Awareness and Presence Amplification in Virtual Socializing, Master's Thesis, 2009:084.
- [1.3] Division of Cultural Heritage, African and Arab museum unit, Text: Adalberto Biasiotti, Drawings: Beatrice Beccaro Migliorati
- [1.4] CDT de la MARNE-2009, La Champagne-La Marne, Conservation préventive
- [1.5] GM862 Product Description, 80272ST10019a Rev. 12 - 2010-10-20

2. Web-links:

- [2.1] <http://en.wikipedia.org/wiki>
- [2.2] <http://translate.google.com>
- [2.3] <http://www.innov-com.org>
- [2.4] <http://www.bardomuseum.tn>
- [2.5] <http://www.wordnik.com/words/pedestal>
- [2.6] http://jr-international.fr/gps-tracer-anti-theft-device-computer_GPSTA_itm_english.html
- [2.7] http://www.kaspersky.com/fr/kaspersky_mobile_security
- [2.8] <http://www.serialwireless.net/Les-differentes-techniques-de.html>
- [2.9] <http://fr.wikitwist.com/applications-nfc-sur-mobile/#axzz2PxICY0d6>
- [2.10] <http://www.polenationaldetracabilite.com/localisation-outdoor,p-133,fr.html>
- [2.11] <http://doumai.pagesperso-orange.fr/IMES/Intrusion/Les%20capteurs/Les%20d%E9tecteur%20IR.htm>
- [2.12] <http://aprs.gids.nl/nmea/>
- [2.13] <http://www.everestauction.com.au/news/31/GPS-Tracker-and-its-necessity.html>
- [2.14] <http://www.polestar.eu/fr/nao-campus/geolocalisation-indoor.html>
- [2.15] <http://alarmeautomoto.com/mouchards-traceurs/256-gtrack.html>

Appendices

Appendix I: Presentation of the host institution

The research laboratory Innov'Com is composed of more than 100 researchers, the majority of which are in graduate training through research. The objectives of this unit are focused on its contribution to the innovation of intelligent systems (cognitive), communicative, cooperative and mobile.



Appendix 1. 1: The host Institution: Innov'Com

I.1-InnovCom's First Specific Object:

Position itself in the involvement of researchers in the framework which involves communication systems => **Expected Result:** participate to promote graduation, training through research and make innovative contributions in the field of basic and applied research on communicating objects by developing models and prototypes patented and enhancement by high-level scientific publications .

I.2- InnovCom Second Specific Object:

Support the development of large communication systems through innovative approaches and co-operators => **Expected Outcome:** To contribute to the development of a research strategy covering innovative topics in the field of intelligent networks and cooperative dynamical systems and communicating systems and high bandwidth with high mobility to meet the requirements of new communication systems bandwidth and quality of service.

I.3- InnovCom Third Specific Object:

Contribute to radiation institutions piecing on National and International environment.

➔ **Outcome:** develop collaborations with laboratories and national and foreign industrial lines of research innovative carriers and common interest.

I.4- Techniques mastered:

- * Computers & Electronics embedded
- * Modelling and high frequency measurements,
- * Advanced techniques for teleprocessing activities,
- * Digital communication techniques,
- * Design and Implementation "On Chip"
- * Tools for programming, design, simulation

I.5- Treated themes:

- * Electromagnetic compatibility and integrity signals
- * Systems Broadband and Mobility Strong (HDFM)
- * Security Administration and Network Architectures (SAAR)
- * Cooperative and Communicating Objects
- * System Integration (SI)

Appendix II: Museums definition followed by Tunisian Examples

A museum is an institution that cares for and conserves a collection of artefacts and other objects of scientific, artistic, cultural, or historical importance and makes them available for public viewing through exhibits that may be permanent or temporary. Most large museums are located in major cities throughout the world and more local ones exist in smaller cities, towns and even the countryside.

Etymology:

The English "museum" comes from the Latin word, and is pluralized as "museums" (or rarely, "musea"). It is originally from the Greek *ΜΟΥΣΕῖον* (*Mouseion*), which denotes a place or temple dedicated to the Muses (the patron divinities in Greek mythology of the arts), and hence a building set apart for study and the arts, especially the Musaeum (institute) for philosophy and research at Alexandria by Ptolemy I Soter about 280 BCE. The first museum/library is considered to be the one of Plato in Athens. However, Pausanias gives another place called "Museum," namely a small hill in Classical Athens opposite the Acropolis.

Purpose:

Museum purposes change from one institution to another. Some favour education over conservation, or vice versa. Some museums seek to reach a wide audience, such as a national or state museum, while some museums have specific audiences. Generally speaking, museums collect objects of significance that comply with their mission statement for conservation and display.

Tunisian museums' history:

The culture of Tunisia is a product of more than three thousand years of history and an important multi-ethnic influx. Ancient Tunisia was a major civilization crossing through history; different cultures, civilizations and multiple successive dynasties contributed to the culture of the country over centuries with varying degrees of influence. Among these cultures were the Carthaginian – their native civilization, Roman, Vandal, Christian, Arab, Islamic, Turkish, and French, in addition to native Berbers. This unique mixture of cultures made Tunisia, with its strategic geographical location in the Mediterranean, the core of some great civilizations of Mare Nostrum. The history of Tunisia reveals this rich past where different successive Mediterranean cultures had a strong presence. After the Carthaginian Republic, the Roman Empire came and left a lasting effect on the land with various monuments and cities such the El-Djem Amphitheater and the archaeological site of the ancient city of Carthage, which is classified as a world heritage site. El Jem is just one of seven world heritage sites found in Tunisia.



Bardo National Museum

Carthage National Museum

Appendix 2. 1: Bardo and Cathage National Museums

In addition to these temples of our cultural heritage, a lot of museums have been established to save a lot of Tunisian history proofs for next generations. Among these museums, we are presenting in details the two most famous museums: Bardo and Carthage national museums.

II.1-Bardo National Museum:

The **Bardo National Museum's** building was originally a 13th-century Hafsids palace, located in the suburbs of Tunis.

a-History:

The fortified military city of Bardo which is the centre of the Husseini power since 1705, witnessed the edification of sumptuous buildings within its walls.

- Ali Pasha, the second sovereign of the dynasty between 1735 and 1756, built a first palace with a monumental entrance staircase guarded by lion statues.
- Between 1824 and 1835, Hussein Bey built the "Small Tunisian Palace" characterized by Moorish Andalousian style.
- Between 1859 and 1864, Mhammed Bey built the harem called "Qasr Al-Badii" which was characterized by an Italian style.

These last two residences, which are close to each other, remained the Bey's residences until 1879. Sadok Bey, who was responsible for the bankruptcy of the kingdom, was obliged to restrain his lifestyle and move to Ksar Said where he had a much more modest residence.

b--Mission:

The objective of the redevelopment project of the Bardo Museum, existing since more than a century, is to make of it a major pole for a high quality cultural development.

With the expansion of its premises, the redeployment of its collections, their suitable, attractive, and didactic exposure, the visitor will be able to better appreciate, understand, and finally appropriate the exposed pieces of art to himself regardless of his intellectual level or age.



Appendix 2. 2: Some of Bardo National Museum's Masterpieces

c- Collections:

The museum displays objects ranging from pre-historical artefacts to modern jewellery. On the first floor gallery, six departments were programmed in the new building. They are dedicated to Prehistory, Phoenician-Punic civilization, the Numidian world, the underwater Mahdia collection, Late Antiquity, and Islam.

The second-floor gallery, called Carthage Gallery, receives the glass making, ceramics, and bronze crafts works, which are dating back to the Roman epoch. The harem's chorus (former Virgil's Hall) receives the monetary treasures and exceptional works. This new presentation is intended to be a testimony of the Tunisian cultural identity. The historical museum, the old palace of Mhammed Bey's harem, conserves almost the totality of its famous mosaics and Roman epoch sculptures collections gathered in the Carthage Hall. Many translation spaces are inserted into the circuit in order to present the national heritage in a didactic manner and highlight its historical journey.

II.2- Carthage National Museum:

Carthage National Museum is an archaeological one, which is located at the hill of Byrsa in the heart of the city of Carthage. Founded in 1875, it is one of the country's most extensive museums. Located near the Cathedral of Saint-Louis of Carthage, it allows the visitor to appreciate the magnitude of the city during the Punic and Roman eras. Some of the best pieces found in excavations are limestone/marble carvings, depicting animals, plants and even human sculptures.

Of special note is a marble sarcophagus of a priest and priestess from the 3rd century BC, discovered in the necropolis of Carthage. The Museum also has a noted collection of masks and jewellery in cast glass, Roman mosaics including the famous "Lady of Carthage", a vast collection of Roman amphoras. It also contains numerous local items from the period of the Byzantine Empire. Also on display are objects of ivory.



Appendix 2. 3: Some of Carthage National Museum's Masterpieces

a-History:

Carthage National Museum was founded in 1875 by Cardinal Charles Martial Lavigerie in the premises of the monastery; its name until 1956 was the Museum Lavigerie. The museum is the product of excavations conducted by European archaeologists, in particular those made by Alfred Louis Delattre. The Annex was used at first to house the items found in searches in the necropolis of Carthage and excavations of the St. Louis hill but also Douimès, the hill of Juno, the Sainte-Monique Hill and also the Carthaginian Christian basilicas. However, many object unearthed were sold to tourists when the museum had a number of examples of similar objects. Carthage museum received its present name in 1956 and opened for the first time as a national museum in 1963. It has undergone extensive restructuring in the 1990s, and has now been redesigned to accommodate new discoveries on the site of Carthage, especially the product of searches conducted as part of the international campaign of the UNESCO, from 1972-1995.

b-Collections:

The museum contains items which reveal a distinct connection with the Levant steeped in Egyptian and in particular Greek culture, and the ties of Carthage with Sicily during the Hellenistic period. Testimonies to these connections are many objects of pottery, oil lamps and amulets discovered in excavating the necropolis. So in order to secure our history treasure, museum's security administrators can use a lot of security systems, to reduce the contraband risk and protect our precious and priceless history.